

# FUSION

USER MANUAL

## JOIN THE GOPRO MOVEMENT

---



[facebook.com/GoPro](https://facebook.com/GoPro)



[youtube.com/GoPro](https://youtube.com/GoPro)



[twitter.com/GoPro](https://twitter.com/GoPro)



[instagram.com/GoPro](https://instagram.com/GoPro)

## TABLE OF CONTENTS

---

Your Fusion	6
Getting Started	8
Navigating Your GoPro	17
Map of Modes and Settings	20
Tips for Capturing with Fusion	22
QuikCapture	24
Capturing Video and Photos	26
Controlling Your GoPro with Your Voice	28
Playing Back Your Content	32
Connecting to Other Devices	33
Offloading Your Content	35
Video Mode: Capture Mode	36
Video Mode: Settings	37
Photo Mode: Capture Modes	41
Photo Mode: Settings	42
Time Lapse Mode: Capture Modes	44
Time Lapse Mode: Settings	46
Protune	50
Customizing Your GoPro	53

## TABLE OF CONTENTS

---

Important Messages	56
Resetting Your GoPro	57
Mounting	59
Removing the Side Door	64
Maintenance	66
Battery Information	68
Troubleshooting	71
Customer Support	73
Trademarks	73
Regulatory Information	73

## YOUR FUSION

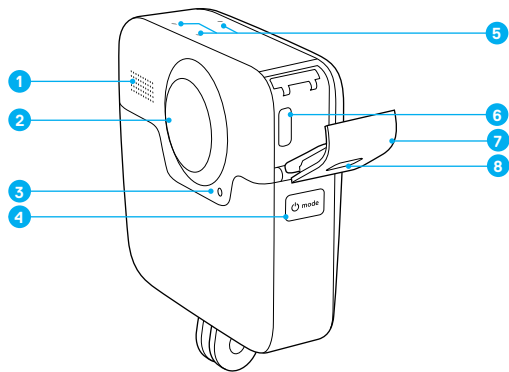

1. Speaker
2. Camera Lens (Back)
3. Status Light
4. Mode Button [  ]

5. Microphones
6. USB-C Port
7. Side Door
8. Latch Release Button

## YOUR FUSION

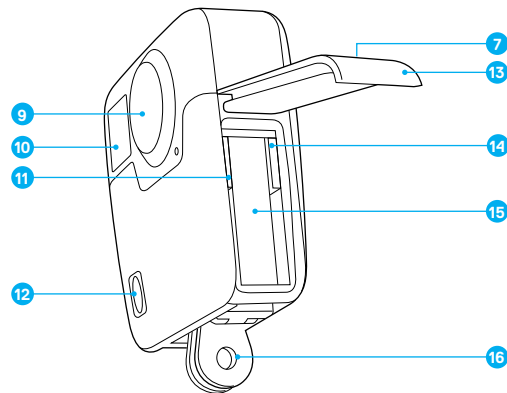

9. Camera Lens (Front)
10. Status Screen
11. Slot for microSD Card 1
12. Shutter Button [  ]

7. Battery Door
13. Battery Door
14. Slot for microSD Card 2
15. Battery
16. Mounting Fingers

## GETTING STARTED

Welcome to your new Fusion! Let's get started.

### MICROSD CARDS

Fusion requires two microSD cards (sold separately). Use brand name memory cards that meet these requirements:

- microSD, microSDHC, or microSDXC
- Class 10 or UHS-II/III rating
- Capacity up to 128GB

For best results, we recommend that the brand, speed rating, and capacity of the cards are the same. For a list of the recommended microSD cards, visit [gopro.com/workwithgopro](http://gopro.com/workwithgopro).

Always think of the two cards as partners. When you replace one, replace the other.

If your cards become full during recording, your camera stops recording and displays *FULL* on the status screen. For cards with different capacities, this message appears when the smaller card becomes full.

**NOTICE:** Use care when handling memory cards. Avoid liquids, dust and debris. As a precaution, power off the camera before inserting or removing the cards. For information about use in acceptable temperature ranges, check the memory card manufacturer's guidelines.

### Inserting the microSD Cards

1. Hold down the Latch Release button on the battery door, then slide the door open.

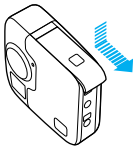

## GETTING STARTED

2. Insert two microSD cards with the labels facing the battery, then close the door.

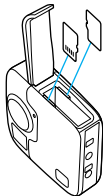











*Note:* To remove a card, press it into the slot with your fingernail and it will pop out.

### Reformatting Your microSD Cards

For best performance, always reformat your microSD cards before first use. To keep the cards in good condition, reformat them on a regular basis.

**NOTICE:** Reformatting erases all of your content, so be sure to offload your photos and videos first.

1. Press the **Mode** button [  ] repeatedly until you get to Settings [  ], then press the **Shutter** button [  ] to select it.
2. Press the **Shutter** button [  ] repeatedly until you get to Preferences [  ].
3. Press the **Mode** button [  ] repeatedly until you get to Format, then press the **Shutter** button [  ] to select it.
4. Press the **Mode** button [  ] to highlight which card(s) you want to reformat, then press the **Shutter** button [  ] to select it.
5. Press the **Mode** button [  ] to highlight Yes, then press the **Shutter** button [  ] to select it.

## GETTING STARTED

---



**WARNING:** Use caution when using your GoPro as part of your active lifestyle. Always be aware of your surroundings to avoid injury to yourself and others.

Abide by all local laws when using your GoPro and related mounts and accessories, including all privacy laws, which may restrict recording in certain areas.

---

### CHARGING THE BATTERY

For the best experience with your new camera, we recommend fully charging the battery before first use.

1. Hold down the Latch Release button on the battery door, then slide the door open.

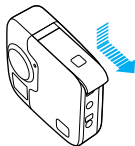

2. Insert the battery, then close the door.

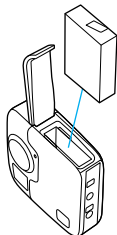

## GETTING STARTED

---

3. Hold down the Latch Release button on the side door, then slide the door open.

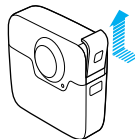

4. Connect the camera to Supercharger or another wall charger (both sold separately) using the included USB-C cable.  
The camera status light on the front of the camera turns on during charging and turns off when charging is complete.

For wall chargers, the battery charges to 100% in about 3.5 hours. Supercharger charges the battery in about 2 hours. For more information, see [Battery Information](#) (page 68).

---

**PRO TIP:** For fastest charging, use GoPro's Supercharger (sold separately) and its included cable. You can also charge your camera with a USB-compatible wall charger or auto charger.

## GETTING STARTED

---

### UPDATING YOUR CAMERA SOFTWARE

To get the latest features and best performance from your GoPro, make sure your camera is always using the most current software.

#### Updating with the GoPro App

When you connect your camera to the GoPro app, you are automatically notified if an update is available.

1. Download the app from the Apple® App Store® or Google Play.™
2. Be sure that the camera contains both microSD cards.
3. Follow the on-screen instructions in the app to connect your camera.  
If an update is available, the app provides instructions for installing it.











#### Updating Manually (with an SD Card Reader/Adapter)

1. Visit [gopro.com/update](https://gopro.com/update).
2. Select your camera, then click the option to update the camera manually.
3. Be sure that the camera contains both microSD cards.
4. Follow the on-screen instructions.

## GETTING STARTED

---

### LOCATING YOUR SOFTWARE VERSION









1. Press the **Mode** button [  ] repeatedly until you get to Settings [  ], then press the **Shutter** button [  ] to select it.
2. Press the **Shutter** button [  ] repeatedly until you get to Preferences [  ].
3. Press the **Mode** button [  ] to highlight About, then press the **Shutter** button [  ] to select it. The software version appears on the first screen.
4. Press the **Shutter** button [  ] to select Done.
5. Press the **Mode** button [  ] repeatedly until you get to Done, then press the **Shutter** button [  ] to select it.

## GETTING STARTED

---

### LOCATING YOUR CAMERA'S USERNAME AND PASSWORD

Your camera's username and password are needed when you connect your camera to other devices. To display this information at any time, complete the steps below.

1. Press the **Mode** button [  ] repeatedly until you get to Settings [  ], then press the **Shutter** button [  ] to select it.
2. Press the **Shutter** button [  ] repeatedly until you get to Connections [  ].
3. Press the **Mode** button [  ] to highlight Cam Info, then press the **Shutter** button [  ] to display the username and password.
4. Press the **Mode** button [  ] repeatedly until you get to Done, then press the **Shutter** button [  ] to select it.

## GETTING STARTED

---

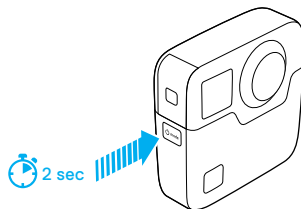

### POWERING ON + OFF

#### To Power On:

Press the **Mode** button [  ]. The camera beeps several times while the camera status lights flash. When information appears on the status screen, your camera is on.

#### To Power Off:

Press and hold the **Mode** button [  ] for two seconds. The camera beeps several times while the camera status lights flash.

*Note: Fusion automatically powers off after 7 minutes of inactivity.*



## GETTING STARTED

### STATUS SCREEN

The status screen contains the following information about modes and settings so you can see the basics for your current setting at a glance:

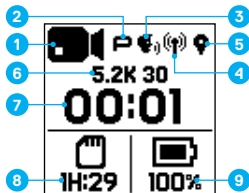

1. Camera Mode
2. Protune™ Status\*
3. Voice Control Status\*
4. Wireless Status\*
5. GPS Status\*
6. Settings
7. Number of Files Captured or Video Duration
8. Remaining microSD Card Storage (based on the card with the lower remaining storage)
9. Battery Status

*Note: The icons and settings that appear on the status screen vary by mode. Those shown above are for Video mode.*

*\*Icon appears if this setting is turned on*

## NAVIGATING YOUR GOPRO

### CHANGING CAPTURE MODES AND SETTINGS

Your Fusion contains four camera modes: Video, Photo, Time Lapse, and Settings.

#### Video [ ]

Video mode contains one capture modes: Video. For a description, see [Video Mode: Capture Mode](#) (page 36).

#### Photo [ ]

Photo mode contains three capture modes: Photo, Burst, and Night. For descriptions, see [Photo Mode: Capture Modes](#) (page 41).

#### Time Lapse [ ]

Time Lapse mode contains three capture modes: Time Lapse Video, Time Lapse Photo, Night Lapse Photo. For descriptions, see [Time Lapse Mode: Capture Modes](#) (page 44).





#### Settings [ ]

Settings contains all of the settings for each camera mode. For details, see [Video Mode: Settings](#) (page 37), [Photo Mode: Settings](#) (page 42), and [Time Lapse Mode: Settings](#) (page 46). Settings also contains the Connections, Voice Control, and Preferences menus.



## NAVIGATING YOUR GOPRO

1. To change modes, press the **Mode** button [  ] repeatedly until you get to the mode that you want.



2. If needed, select a new capture mode and settings:
  - a. Press the **Mode** button [  ] repeatedly until you get to Settings [  ], then press the **Shutter** button [  ] to select it.
  - b. Press the **Shutter** button [  ] repeatedly until you get to the camera mode that you want.





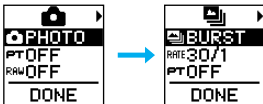

- c. Press the **Mode** button [  ], then press the **Shutter** button [  ] repeatedly until you get to the capture mode that you want.

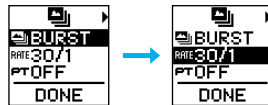

## NAVIGATING YOUR GOPRO

- d. Press the **Mode** button [  ] until you get to the setting that you want to change.



- e. Press the **Shutter** button [  ] repeatedly until you get to the option that you want.
- f. Press the **Mode** button [  ] repeatedly until you get to Done, then press the **Shutter** button [  ] to select it.

**PRO TIP:** To exit Settings and begin recording immediately, press and hold the **Shutter** button [  ].

## MAP OF MODES AND SETTINGS

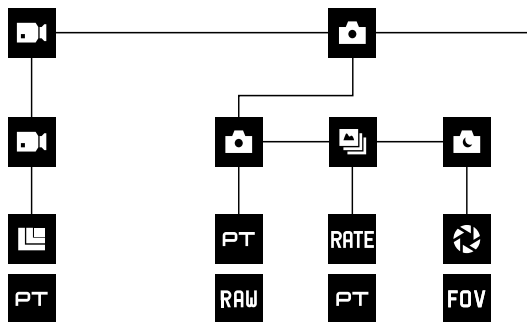

## MAP OF MODES AND SETTINGS

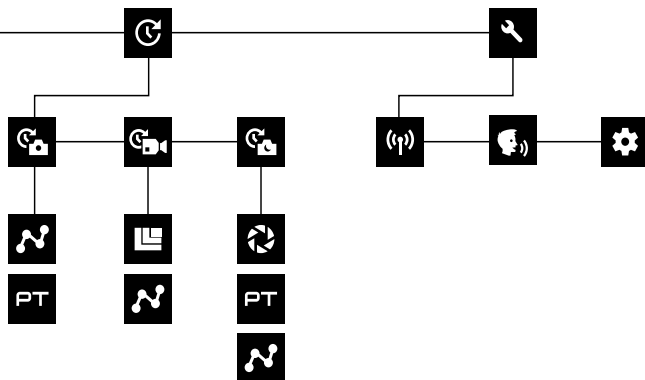

 Burst

 Connections

**FOV** FOV

**FPS** FPS

 Interval

 Night Photo

 Night Lapse Photo

 Photo Mode / Photo

 Preferences

**PT** Protune

**RATE** Rate

**RAW** RAW Format

 Resolution

 Settings

 Shutter

 Time Lapse Mode

 Time Lapse Photo

 Time Lapse Video

 Video Mode / Video

 Voice Control

## TIPS FOR CAPTURING WITH FUSION

---

If you are new to capturing spherical content, below are some tips to help you get the best results from Fusion.

- Fusion captures everything around you, regardless of where the camera is pointed. However, for best results, aim one of the lenses directly at the main subject.
- OverCapture lets you capture content in all directions from a single point of view. So, you do not need as many cameras to ensure that you get the shot. And you can select the content that is important to you **after** you capture.
- For the best results, attach Fusion to the mounts that came with the camera. Using the mounts moves the camera away from your hand and helps reduce the chances that your hand appears in the shot.
- When using Fusion as a handheld camera without a mount, group most of your fingers underneath the camera near the mounting fingers. This placement reduces the chance that your hand appears in the shot:

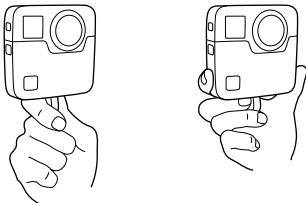

## TIPS FOR CAPTURING WITH FUSION

---

- For more control during editing, capture with Protune turned on.
- To prevent additional work during editing, do not rest Fusion on its side when capturing.
- Keep editing in mind when you are capturing with Fusion. For example, remember to hide yourself and your supporting mounts and equipment somewhere that is easily blended during editing.



**WARNING: The dual lenses of Fusion are unprotected and are susceptible to scratches, if not cared for properly. Always store Fusion with the provided lens protection and avoid resting the lens on any surface. Scratches to the lens are not covered by the warranty.**

---

## QUIKCAPTURE

---

QuikCapture is the fastest way to capture video or time lapse photos with Fusion. Because the camera is powered on only when it is capturing, you also conserve battery power.

To capture other types of content, see [Capturing Video and Photos](#) (page 26).

### CAPTURING VIDEO WITH QUIKCAPTURE

1. With the camera powered off, press the **Shutter** button [  ].

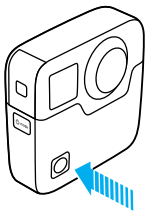

Your camera powers on, beeps several times, and automatically begins capturing video. The camera status lights blink while the camera is recording. The default video resolution is 5.2K30.

2. To stop recording, press the **Shutter** button [  ] again. The camera stops recording, beeps several times, and automatically powers off.

## QUIKCAPTURE

---

### CAPTURING TIME LAPSE WITH QUIKCAPTURE

The Time Lapse mode is perfect for showing how a scene changes over time. With Time Lapse Photo or Night Lapse Photo, you can capture a series of photos to be sure you get the shot you want.

1. With the camera powered off, press and hold the **Shutter** button [  ] until capture begins.

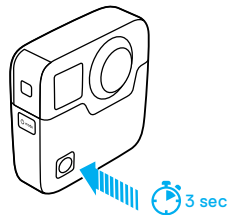

Your camera powers on, beeps several times, and automatically begins capturing in the current Time Lapse capture mode (Time Lapse Video, Time Lapse Photo, or Night Lapse Photo). The camera status lights blink once for each photo captured.

2. To stop capturing, press the **Shutter** button [  ] again. The camera stops recording, beeps several times, and automatically powers off to maximize battery life.

### TURNING QUIKCAPTURE OFF



QuikCapture is on by default. To turn it off, connect Fusion to the GoPro app and turn off QuikCapture in the settings list. For details, see [Connecting to Other Devices](#) (page 33).

## CAPTURING VIDEO AND PHOTOS

---

### CAPTURING VIDEO AND PHOTOS

You can also use a more traditional method to capture video and photos in which you leave the camera powered on and capture, as needed. Unlike QuikCapture, the camera remains on when you are not capturing, so you must manually power it off to save battery life. (Fusion automatically powers off after 7 minutes of inactivity.)

1. Press the **Mode** button [  ] to power on the camera.
2. Select a mode and settings. For details, see [Changing Modes and Settings](#) (page 17).
3. Press the **Shutter** button [  ]. The camera beeps and the camera status lights flash while the camera is capturing.
4. To stop capturing video or time lapse, press the **Shutter** button [  ]. The camera beeps and the camera status lights flash quickly.

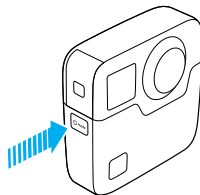

## CAPTURING VIDEO AND PHOTOS

---



### ADDING HIGHLIGHT TAGS

You can mark specific moments in your video during recording or playback with HiLight Tags. HiLight Tags make it easy to find the best highlights to share.

To add a HiLight Tag, press the **Mode** button [  ] or tap [  ] in the GoPro app.

## CONTROLLING YOUR GOPRO WITH YOUR VOICE







---

You can control Fusion with your voice using a set of specific commands (see list below).



*Note: Voice Control performance may be impacted by distance, wind, and noisy conditions. Keep the product clean and clear of debris.*

### USING VOICE CONTROL

Voice Control works best when you and your GoPro are in close proximity.

1. Press the **Mode** button [  ] repeatedly until you get to Settings [  ], then press the **Shutter** button [  ] to select it.
2. Press the **Shutter** button [  ] repeatedly until you get to Voice Control [  ].
3. Press the **Mode** button [  ], then press the **Shutter** button [  ] to turn on Voice Control.

*Note: To conserve battery life, turn off Voice Control when you're not using it.*

4. Press the **Mode** button [  ] repeatedly until you get to Done, then press the **Shutter** button [  ] to select it.
5. Say a command from [List of Voice Commands](#) (page 29).

### LIST OF VOICE COMMANDS

Two types of commands are available with Voice Control:

- Action commands let you immediately capture video or photos. For example, if you just stopped recording video, you can say the command to take a photo or begin capturing time lapse—without having to first change the mode.
- Mode commands are useful if you want to select a mode and then use the **Shutter** button [  ] to capture.

## CONTROLLING YOUR GOPRO WITH YOUR VOICE

---

Your camera does not need to be in a specific mode to capture video or photos. You can use the action commands from any mode. Your camera captures video or photos based on the settings you previously selected.

Action Command	Description
GoPro start recording	Starts capturing video
GoPro HiLight	Adds a HiLight Tag to video during recording
That was sick	Adds a HiLight Tag to video during recording
GoPro stop recording	Stops capturing video
GoPro take a photo	Captures a single photo
GoPro shoot burst	Captures burst photos
GoPro start time lapse	Starts capturing time lapse
GoPro stop time lapse	Stops capturing time lapse
GoPro turn off	Powers off the camera

## CONTROLLING YOUR GOPRO WITH YOUR VOICE

---

Mode Command	Description
GoPro Video mode	Changes the camera mode to Video (does <i>not</i> capture video)
GoPro Photo mode	Changes the camera mode to Photo mode (does not capture photos)
GoPro Burst mode	Changes the camera mode to Burst mode (does not capture burst photos)
GoPro Time Lapse mode	Changes the camera mode to Time Lapse (does not capture time lapse photos)











For the most updated list of commands, visit [gopro.com/help](https://gopro.com/help).

**PRO TIP:** If you are recording video or time lapse, you must stop recording before issuing a new command.









## CONTROLLING YOUR GOPRO WITH YOUR VOICE

---

### CHANGING YOUR VOICE CONTROL LANGUAGE

1. Press the **Mode** button [  ] repeatedly until you get to Settings [  ], then press the **Shutter** button [  ] to select it.
2. Press the **Shutter** button [  ] repeatedly until you get to Voice Control [  ].
3. Press the **Mode** button [  ] repeatedly until you get to Voice Control Language [  ], then press the **Shutter** button [  ] to select a new language.
4. Press the **Mode** button [  ] to highlight Done, then press the **Shutter** button [  ] to select it.

### TURNING OFF VOICE CONTROL

1. Press the **Mode** button [  ] repeatedly until you get to Settings [  ], then press the Shutter button [  ] to select it.
2. Press the **Shutter** button [  ] repeatedly until you get to Voice Control [  ].
3. Press the **Mode** button [  ], then press the **Shutter** button [  ] to turn off Voice Control.
4. Press the **Mode** button [  ] repeatedly until you get to Done, then press the **Shutter** button [  ] to select it.



## PLAYING BACK YOUR CONTENT

---

You can play back your content on a computer or mobile device.

### VIEWING VIDEOS AND PHOTOS ON A COMPUTER

To play back your video and photos on a computer, you must first transfer these files to a computer. For details, see [Offloading Your Content](#) (page 35).

*You can also insert the microSD cards directly into a computer.*

### VIEWING VIDEOS AND PHOTOS ON A MOBILE DEVICE

1. Connect your camera to GoPro app. For details, see [Connecting to Other Devices](#) (page 33).
2. Use the controls on the app to play back your footage on your smartphone/tablet. You can move the device itself or navigate with the touch screen to explore the full 360 image.

---

**PRO TIP:** While playing back your video with the GoPro app, you can mark the best moments by tapping [  ] to add a HiLight Tag.

## CONNECTING TO OTHER DEVICES

---

### CONNECTING TO THE GOPRO APP











The GoPro app lets you control your camera remotely using a smartphone or tablet. Features include full camera control, live preview, playback and sharing of content, and camera software updates.

#### Connecting to the GoPro App for the First Time

1. Download the GoPro app to your mobile device from the Apple® App Store® or Google Play™.
2. Follow the app's on-screen instructions to connect your camera.

#### Reconnecting to the GoPro App

After connecting to the GoPro app for the first time, you can connect in the future through the Connections menu [  ] on the camera.

1. Turn on your camera's wireless:
  - a. Press the **Mode** button [  ] repeatedly until you get to Settings [  ], then press the **Shutter** button [  ] to select it.
  - b. Press the **Shutter** button [  ] repeatedly until you get to Connections [  ].
  - c. Press the **Mode** button [  ] to highlight Turn On, then press the **Shutter** button [  ] to select it.
  - d. Press the **Mode** button [  ] to highlight Yes, then press the **Shutter** button [  ] to turn on wireless.
  - e. Press the **Mode** button [  ] repeatedly until you get to Done, then press the **Shutter** button [  ] to select it.
2. In the GoPro app, follow the on-screen instructions to connect your camera.

## CONNECTING TO OTHER DEVICES

---

### CONNECTING TO THE SMART REMOTE OR REMO

For details about connecting Fusion to the Smart Remote or Remo (Waterproof Voice Activated Remote), see the user manual for the device at [gopro.com/help](http://gopro.com/help).

### CONNECTING TO BLUETOOTH DEVICES









You can connect your GoPro to Bluetooth devices that track statistics about your activity. That data is then automatically added to your video to create a more engaging record of your activity.

1. Connect your camera to the GoPro app. For details, see [Connecting to the GoPro App](#) (page 33).
2. In the app, open the camera's settings, then tap Bluetooth Devices.
3. Follow the on-screen instructions.

### SELECTING A DIFFERENT CONNECTION SPEED

By default, your GoPro uses the 5GHz Wi-Fi band to connect to other devices. This band provides faster transfer speed than the 2.4GHz band. The transfer speed affects how long it takes for your video and photos to be copied to your phone.

To use the 5GHz band, your phone and region must also work with that band. Otherwise, you can change the Wi-Fi band on your GoPro to 2.4GHz.

1. Press the **Mode** button [  ] repeatedly until you get to Settings [  ], then press the **Shutter** button [  ] to select it.
2. Press the **Shutter** button [  ] repeatedly until you get to Connections [  ].
3. Press the **Mode** button [  ] to highlight Band.
4. Press the **Shutter** button [  ] to select 2.4GHz.
5. Press the **Mode** button [  ] to highlight Done, then press the **Shutter** button [  ] to select it.

## OFFLOADING YOUR CONTENT

---

Fusion Studio is free GoPro software that lets you import, stitch, trim, and share your spherical content. Although Fusion video is captured with a Spherical FOV, the Overcapture feature lets you extract a high-quality 1080p30 video that is optimized for flat screens.

### OFFLOADING YOUR CONTENT TO A COMPUTER

To play back your video and photos on a computer or mass storage device, you must first transfer these files to a computer. Transferring also frees up space on your microSD cards for new content.

1. Download and install Fusion Studio from [gopro.com/apps](http://gopro.com/apps).
2. Connect the camera to your computer using the included USB-C cable.
3. Power on the camera and follow the on-screen instructions in the software to view and stitch your content.

### OFFLOADING YOUR CONTENT USING A CARD READER

You must use a card reader to offload RAW photos.

1. Download and install Fusion Studio from [gopro.com/apps](http://gopro.com/apps).
2. For each microSD card, complete these steps:
  - a. Insert a microSD card into a card reader, then connect the card reader to the computer.
  - b. Use your computer's file explorer to manually transfer the files from the card to your computer.
3. Open Fusion Studio and follow the on-screen instructions to view and stitch your content.

## VIDEO MODE: CAPTURE MODE

---

Video mode contains one capture mode: Video (default). For details about how to change settings, see [Changing Modes and Settings](#) (page 17).

### VIDEO

This capture mode records video. The default resolution is 5.2K30. For more information, see these topics:

 [Fusion Video Resolutions](#) (page 39)

 [Protune](#) (page 50)

## VIDEO MODE: SETTINGS

---

### VIDEO RESOLUTION

Video resolution (RES) refers to the number of horizontal lines in the video. For example, 3K means that the video has 3000 horizontal lines, each with a width of 1504 pixels. Higher numbers of lines and pixels result in greater detail and clarity. So, a video with resolution of 5.2K is considered higher quality than 3K because it consists of 4992 lines, each with a width of 2496 pixels.

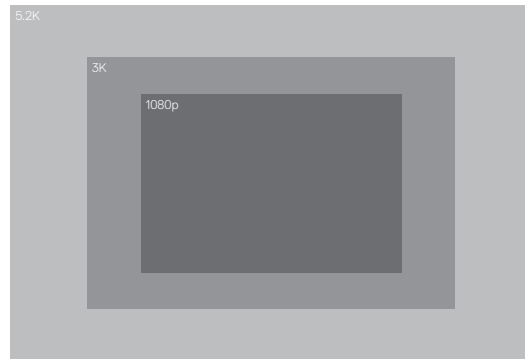

## VIDEO MODE: SETTINGS

---

Use this table to help you determine the best resolution for your activity.

Video Resolution	Best Use
5.2K30	Beautiful high-resolution content. Enables 1080p30 OverCapture videos with the traditional GoPro look and feel. Results in a large viewing area, so is recommended for most situations.
3K60	High frame rate yields the smoothest, most immersive results for capturing fast-action activities. Enables 720p60 fixed-frame OverCapture videos. This FPS gives you the most natural playback in head-mounted displays (HMDs) and enables slow motion during editing.

## VIDEO MODE: SETTINGS

---

### FRAMES PER SECOND (FPS)

Frames per second (FPS) refers to the number of video frames that are captured in each second.

When selecting a resolution and FPS combination, consider the activity that you want to capture. For more details, see [Video Resolution](#) (page 37).

### ASPECT RATIO

Fusion video resolutions are captured with a 16:9 aspect ratio, which is the standard for televisions and editing programs.

### FIELD OF VIEW (FOV)

The field of view (FOV) refers to how much of the scene (measured in degrees) can be captured through the camera lens. The FOV for all Fusion video is Spherical, which captures a full 360 view.

### FUSION VIDEO RESOLUTIONS

Video Resolution (RES)	FPS (NTSC/PAL)*	FOV	Screen Resolution
5.2K (default)	30/25	Spherical	4992X2496
3K	60/50	Spherical	3000X1504

\*NTSC and PAL refer to the video format, which depends on the region that you are in. For more information, see [Video Format](#) (page 54).

## VIDEO MODE: SETTINGS

---

### HIGH RESOLUTIONS/HIGH FRAME RATES

When capturing video at high resolutions or high frame rates in warm ambient temperatures, the camera may become warm and use more power.

In addition, lack of airflow around the camera and using the camera with the GoPro app further increase camera temperature and power consumption, and decrease camera recording time.

Your camera was designed to identify conditions of overheating and shuts down when needed. If the camera gets too hot, a message appears on the screen indicating that the camera is shutting down. For details, see [Important Messages](#) (page 56).

When recording in high-performance video modes, capture shorter video clips when in stationary use, and/or limit your use of features that increase power consumption, such as the GoPro app. To control your camera remotely at higher temperatures, use a GoPro remote or Remo (Waterproof Voice Activated Remote) (both sold separately) instead of the GoPro app.

### PT PROTUNE

Protune is available for the Video capture mode. For details about Protune settings, see [Protune](#) (page 50).

## PHOTO MODE: CAPTURE MODES

---

Photo mode contains three capture modes: Single (default), Night, and Burst. All photos are captured at 18MP with a Spherical FOV. Each capture mode has its own settings. For details about how to change settings, see [Changing Modes and Settings](#) (page 17).

### SINGLE

Single captures a single photo when you press the **Shutter** button. For more information, see these topics:

**RAW** [RAW Format](#) (page 43)

**PT** [Protune](#) (page 50)

### NIGHT

Night captures photos in dim to dark light. The shutter remains open longer to let in more light in dark environments, so Night photo is not recommended for handheld shots or mounted shots where the camera might move during exposure. For more information, see these topics:

 [Shutter \(Night Photo\)](#) (page 42)

**PT** [Protune](#) (page 50)

### BURST

Burst captures up to 30 photos in 1 second, so it is perfect for capturing fast-moving activities. For more information, see these topics:

**RATE** [Rate](#) (page 42)

**PT** [Protune](#) (page 50)

## PHOTO MODE: SETTINGS

---

### RATE RATE

This setting applies only to Burst. Available rates:

- 30 photos in 1, 2, 3, or 6 seconds
- 10 photos in 1, 2, or 3 seconds
- 5 photos in 1 second
- 3 photos in 1 second

The default rate is 30 photos in 1 second.



### SHUTTER (NIGHT PHOTO)

Within Photo mode, Shutter applies only to Night Photo. This setting lets you determine the amount of time that the shutter is open. The options for this setting are Auto, and 2, 5, 10, 20, and 30 seconds. The default option is 2 seconds.

Settings	Examples
Auto (up to 2 sec)	Sunrise, sunset, dawn, dusk, twilight, night
2 sec, 5 sec, 10 sec	Dawn, dusk, twilight, traffic at night, Ferris wheel, fireworks, light painting
20 sec	Night sky (with light)
30 sec	Night stars, Milky Way (complete darkness)

**PRO TIP:** To reduce the amount of blur when using Night photo, mount your camera on the Fusion Grip tripod or other surface that is stable and cannot move.

## PHOTO MODE: SETTINGS

---

### RAW RAW FORMAT

When this setting is turned on, all photos are captured with an accompanying .jpg image for immediate viewing on your camera or sharing with the GoPro app. RAW photos are saved as .gpr files, which are based on the Adobe .dng format. These files can be used in Adobe Camera Raw (ACR), version 9.7 or later. You can also use Adobe Photoshop Lightroom CC (2015.7 release or later) and Adobe Photoshop Lightroom 6 (version 6.7 or later).

RAW Format is available only for the Photo capture mode. The options for this setting are Off (default) and On.

---

**PRO TIP:** Photos in .gpr format are captured in the same location and with the same file name as .jpg files. To access them, insert your microSD cards into a card reader and locate the files with your computer's file explorer.

### PT PROTUNE

Within Photo mode, Protune is available for all capture modes (Photo, Night, and Burst). For details about Protune settings, see [Protune](#) (page 50).

## TIME LAPSE MODE: CAPTURE MODES

---

Time Lapse mode contains three capture modes: Time Lapse Video, Time Lapse Photo (default), and Night Lapse Photo. Each capture mode has its own settings. For details about how to change settings, see [Changing Modes and Settings](#) (page 17).

### TIME LAPSE VIDEO

Time Lapse Video creates video from frames captured at specific intervals. This option lets you capture a time lapse event and immediately view or share it as a video. Time Lapse Video is available in both resolutions and is captured without audio.

The default resolution for Time Lapse Video is 5.2K30, with the default interval set at 0.5 second. For more information, see these topics:

 [Fusion Video Resolutions](#) (page 39)

 [Interval \(Time Lapse\)](#) (page 47)

### TIME LAPSE PHOTO

Time Lapse Photo captures a series of photos at specified intervals. Use this mode to capture photos of any activity, then choose the best ones later.

The default interval for Time Lapse Photo is set at 0.5 second. For more information, see these topics:

 [Interval \(Time Lapse\)](#) (page 47)

**PT** [Protune](#) (page 50)

## TIME LAPSE MODE: CAPTURE MODES

---

### NIGHT LAPSE PHOTO

Night Lapse Photo captures a series of photos at set intervals when there is minimal light. The shutter remains open longer to let in more light in dark environments.

For Night Lapse Photo, the default Interval is Auto and the default Shutter setting is 2 seconds. For more information, see these topics:

 [Shutter \(Time Lapse\)](#) (page 49)

 [Interval \(Time Lapse\)](#) (page 47)

**PT** [Protune](#) (page 50)

## TIME LAPSE MODE: SETTINGS

---

### TIME LAPSE VIDEO RESOLUTION AND FOV

Video resolution (RES) refers to the number of horizontal lines in the video. For example, 3K means that the video has 3000 horizontal lines, each with a width of 1504 pixels. Higher numbers of lines and pixels result in greater detail and clarity. So, a video with resolution of 5.2K is considered higher quality than 3K because it consists of 5228 lines, each with a width of 2624 pixels.

The field of view (FOV) refers to how much of the scene (measured in degrees) can be captured through the camera lens.

Time Lapse Video is available in all resolutions.

### FOV FIELD OF VIEW (FOV) FOR TIME LAPSE

The FOV for all time lapse capture modes is Spherical.

## TIME LAPSE MODE: SETTINGS

---



### INTERVAL (TIME LAPSE)

The Interval setting determines the amount of time that passes between each captured frame.

#### Time Lapse Photo and Time Lapse Video Intervals

Available intervals for Time Lapse Video are 0.5 (default), 1, 2, 5, 10, 30, and 60 seconds.

Interval	Examples
0.5-2 seconds	Surfing, biking or other sport
2 seconds	Busy street corner
5-10 seconds	Clouds or outdoor scenes with long durations
10-60 seconds	Lengthy activities, such as construction or artwork



## TIME LAPSE MODE: SETTINGS

---

### Night Lapse Photo Interval

Interval determines the rate at which photos are captured. Night Lapse intervals are Auto, 4, 5, 10, 15, 20, and 30 seconds, and 1, 2, 5, 30, and 60 minutes.

Auto (default) causes the Interval to match the Shutter setting. For example, if Shutter is set to 10 seconds and Interval is set to Auto, your camera captures a photo every 10 seconds. Photos are captured at 18MP.

Interval	Examples
Auto	Great for all exposures. Captures as quickly as possible, depending on the Shutter setting.
4-5 seconds	Evening city scene, street lighting, or scenes with movement
10-15 seconds	Dim lighting with slow scene changes, like night clouds with a bright moon
20-30 seconds	Very low light or very slow scene changes, like stars with minimal ambient or street light

## TIME LAPSE MODE: SETTINGS

---



### SHUTTER (TIME LAPSE)

Within Time Lapse mode, this setting applies only to Night Lapse Photo. Shutter lets you determine the amount of time that the shutter is open. The default option is 2 seconds.

Use this table to help you select the most appropriate setting for your activity:

Settings	Examples
Auto (up to 2 sec)	Sunrise, sunset, dawn, dusk, twilight, night
2 sec, 5 sec, 10 sec	Dawn, dusk, twilight, traffic at night, Ferris wheel, fireworks, light painting
15 sec, 20 sec	Night sky (with light)
30 sec	Night stars, Milky Way (complete darkness)

**PRO TIP:** To reduce the amount of blur when using Night Lapse Photo, mount your camera on the Fusion Grip tripod or other surface that is stable and cannot move.



### PROTUNE

Within Time Lapse mode, Protune is available for Time Lapse Photo and Night Lapse Photo. For details about Protune settings, see [Protune](#) (page 50).

## PROTUNE

---

Protune unlocks the camera's full potential, yielding stunning image quality and cinema-caliber video and photos optimized for professional productions. Protune gives content creators more flexibility and workflow efficiency than ever before.

Protune is compatible with professional color correction tools, Fusion Studio, and other video and photo editing software.

Protune enables manual control of ISO and EV Comp for advanced control and customization of your video footage and photos.

### PT PROTUNE

Protune is available as an advanced setting for supported capture modes. The options for this setting are Off (default) and On. When Protune is on, [ **PT** ] appears on the camera screens.

Protune is not available for Time Lapse Video. Protune is available for all video and photo resolutions.

Changes that you make to Protune settings in one capture mode apply only to that capture mode. For example, changing the EV Comp for Night Photo does not affect EV Comp for Burst photos.

## PROTUNE

---

### ISO ISO

ISO determines the camera's sensitivity to light, and creates a tradeoff between brightness and resulting image noise. Image noise refers to the degree of graininess in the image.

In low light, higher ISO values result in brighter images, but with greater image noise. Lower values result in lower image noise, but darker images. When you change this setting, the touch display immediately shows you the effect on your image.

ISO values for photos:



ISO values for video:

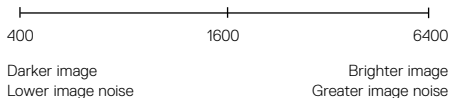

## PROTUNE

---

ISO behavior depends on the Shutter setting:

- Shutter set to Auto: The ISO that you select is used as the maximum ISO value. The ISO value that is applied might be lower, depending on the lighting conditions. Available ISO values are 6400, 3200, 1600, 1200, 800, 400.
- Shutter *not* set to Auto: The ISO that you select is used as the maximum ISO value, unless you tap [  ] at the bottom of the screen to lock the value. Available ISO values are 6400, 3200, 1600, 1200, 800, and 400.



### EXPOSURE VALUE COMPENSATION (EV COMP)

Exposure Value Compensation affects the brightness of your video or photo. Adjusting this setting can improve image quality when shooting in environments with contrasting lighting conditions.

Options for this setting range from -2.0 to +2.0. The default setting is 0. Higher values result in brighter images.

**PRO TIP:** Exposure Value Compensation adjusts brightness within the existing ISO setting. If brightness has already reached the ISO setting in a low-light environment, increasing the Exposure Value Compensation does not have any effect. To continue increasing the brightness, select a higher ISO value.

### RESET









This option resets all Protune settings to their default values.

## CUSTOMIZING YOUR GOPRO

---

From changing the beep volume to turning off the status lights, you can set up your camera to work the way that you want.

### CHANGING PREFERENCES

1. Press the **Mode** button [  ] repeatedly until you get to Settings [  ], then press the Shutter button [  ] to select it.
2. Press the **Shutter** button [  ] repeatedly until you get to Preferences [  ].
3. Press the **Mode** button [  ] repeatedly until you get to the setting that you want to change.
4. Press the **Shutter** button [  ] to select a new option.
5. Press the **Mode** button [  ] repeatedly until you get to Done, then press the **Shutter** button [  ] to select it.



### BEEP VOLUME

Sets the volume of your GoPro's alerts. The options are Off, Low, Medium, and High (default).



### LED

Sets which status lights blink. The options are All On (default) and All Off.

**PRO TIP:** Turn the status lights off if you are capturing in an area with windows or mirrors that might cause reflection in the shot.

## CUSTOMIZING YOUR GOPRO

---



DATE



TIME

The time and date are automatically updated when you connect your camera to the GoPro app or Fusion Studio. However, you can manually change these settings, if needed.

*Note: If the battery is removed from the camera for an extended period of time, you must reset the date and time (automatically or manually).*



GPS

Captures the location where your video and photos were taken. To see this information, view the video or photos on a compatible desktop or mobile application. For details, visit [gopro.com/help](https://gopro.com/help).

This setting is available only when you connect Fusion to the GoPro app. For details, see [Connecting to the GoPro App](#) (page 33).



VIDEO FORMAT

Sets the regional frame rates that your camera uses for recording and playing back video on a TV/HDTV. Selecting the appropriate option for your region helps prevent flicker when capturing video indoors.

Setting	Description
NTSC (default)	Select this option to play back your video on an NTSC TV (most televisions in North America)
PAL	Select this option to play back your video on a PAL TV (most televisions outside of North America)

## CUSTOMIZING YOUR GOPRO

---



STATUS SCREEN LIGHT

Controls the backlight on the status screen. The options are On (default) and Off.



LANGUAGE

Sets the language that appears on the camera. This setting is available only when you connect Fusion to the GoPro app. For details, see [Connecting to the GoPro App](#) (page 33).

## IMPORTANT MESSAGES

---

Fusion alerts you whenever there is an issue with the camera or microSD cards. The most important messages that you might see are listed below.

### TEMPERATURE MESSAGE

---

#### TOO HOT - SHUTTING DOWN

A message appears on the status screen when the camera becomes too hot and needs to cool down. Simply let it sit and cool before attempting to use it again. Your camera was designed to identify conditions of overheating and shuts down when needed.

---

### FILE REPAIR ICON

---

#### FILE DAMAGED

If recording stopped abruptly and the video file was not properly saved, the file might become corrupted. If this happens, the camera displays a *FILE DAMAGED* message. Press the Shutter button to repair the file. When this process is finished, you receive a message stating whether the repair was successful or failed. Press any button to continue using the camera.

---

### MICROSD CARD MESSAGES

---

#### NO SD

No card present. The camera requires a microSD, microSDHC or microSDXC card (sold separately) to capture videos and photos. The message indicates which card is missing.

---

#### SD CARDS FULL

The cards are full. Delete some files or insert different cards.

---

#### SD ERROR

The camera is unable to read the card formatting. Reformat the cards in the camera.

---

## RESETTING YOUR GOPRO

---

### RESTARTING YOUR GOPRO

If your camera is not responding, press and hold the **Mode** button [  ] for 8 seconds to shut down the camera and then restart it. All settings are retained.









### RESETTING ALL SETTINGS TO THE DEFAULTS

This option resets all of your camera settings to the defaults, except Date, Time, and your camera's username and password.

1. Connect Fusion to the GoPro app.
2. Open the settings, and then tap Reset Defaults. For details, see [Connecting to Other Devices](#) (page 33).

### RESETTING THE CONNECTIONS









This option clears your connections list and resets the camera's password. If you reset the connections, you must reconnect any desired devices to your GoPro.

1. Press the Mode button [  ] repeatedly until you get to Settings [  ], then press the Shutter button [  ] to select it.
2. Press the Shutter button [  ] repeatedly until you get to Connections [  ].
3. Press the Mode button [  ] repeatedly until you get to Reset, then press the Shutter button [  ] to select it.
4. Press the Mode button [  ] to highlight Reset, then press the Shutter button [  ] to select it. Fusion automatically resets the connections and powers off.

## RESETTING YOUR GOPRO

### RESTORING FACTORY SETTINGS

Follow the steps below to reset all settings and the camera's password, and unregister the camera from your GoPro Plus account. This option is useful if you are reselling your camera and want to reset it to its original state.

1. Press the Mode button [  ] repeatedly until you get to Settings [  ], then press the Shutter button [  ] to select it.
2. Press the Shutter button [  ] repeatedly until you get to Preferences [  ].
3. Press the Mode button [  ] repeatedly until you get to Reset, then press the Shutter button [  ] to select it.
4. Press the Mode button [  ] to highlight Reset, then press the Shutter button [  ] to select it. Fusion automatically restores the factory settings and restarts.

Restoring factory settings does not erase all content from your microSD card. To clear your microSD card, see [Reformatting Your microSD Cards](#) (page 9).

## MOUNTING

### ATTACHING YOUR CAMERA TO FUSION MOUNTS

The Fusion Mounts make it easy to attach the camera to curved and flat surfaces of bikes, vehicles, and gear. Fusion is waterproof to 16ft (5m) with the doors closed—no additional housing is needed when using the camera in or around water.

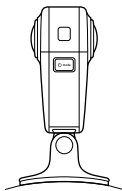

**Curved Fusion Mount**

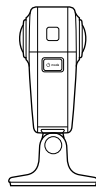

**Flat Fusion Mount**

1. Adhere the Fusion Mount to a dry, clean, smooth surface. Be sure to follow the [Mounting Guidelines](#) (page 60).
2. Use the thumb screw to attach the mounting fingers on Fusion to the mount.

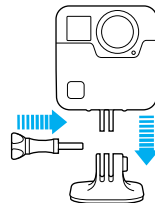

## MOUNTING

---

### MOUNTING GUIDELINES

Follow these guidelines when attaching adhesive mounts:

- Attach the adhesive mounts at least 24 hours before use.
- Adhesive mounts must be mounted only on smooth surfaces. Porous or textured surfaces do not enable a proper bond. When applying the mount, firmly press it into place and ensure full contact over the entire surface.
- Apply adhesive mounts only to clean, dry surfaces. Wax, oil, dirt or other debris reduce adhesion, which can result in a weak bond and risk of losing the camera should the connection fail.
- Attach adhesive mounts in room temperature conditions. Adhesives do not bond properly if applied in cold or damp environments to cold or damp surfaces.
- Check state and local regulations and laws to ensure that attaching a camera to equipment (such as hunting equipment) is permitted. Always comply with regulations that restrict the use of consumer electronics or cameras.
- During water activities, use a camera tether (sold separately) for added security to keep your camera afloat.

## MOUNTING

---

**WARNING:** The Curved Fusion Mount is not recommended for helmet mounting. To mount Fusion on a helmet, use the Curved Adhesive Mount and Mounting Buckle. These items are available in the Grab Bag, sold separately at [gopro.com](https://gopro.com).

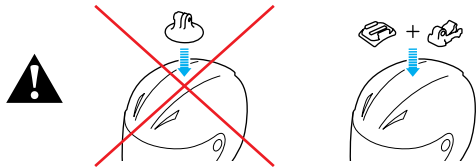

To avoid injury, do not use a tether when mounting the camera on a helmet. Do not mount the camera directly on skis or snowboards.

For more information about mounts, visit [gopro.com](https://gopro.com).

**WARNING:** If using your camera with a GoPro mount or strap intended for use with a helmet, always select a helmet that meets the applicable safety standard.



Choose the right helmet for your particular sport or activity and make sure that it is the right fit and size for you. Inspect your helmet to ensure that it is in good condition, and follow the helmet manufacturer's instructions on safe helmet use.

Any helmet that has sustained a major impact should be replaced. No helmet can protect against injury in every accident.

## MOUNTING

---

### REMOVING THE MOUNTING FINGERS

Removing the mounting fingers lets you rest Fusion on the bottom of the camera.

1. Flip up the tabs on the mounting fingers.

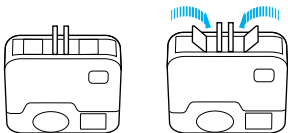

2. Slide the mounting fingers out of the camera.

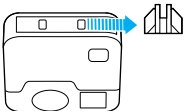

## MOUNTING

---

### RE-ATTACHING THE MOUNTING FINGERS

The mounting fingers let you attach Fusion to GoPro mounts.

1. Slide the mounting fingers into the camera.

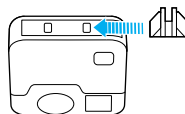

2. Press the tabs into place.

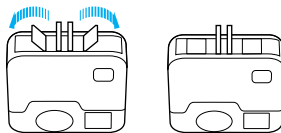



## REMOVING THE SIDE DOOR

---

In some situations, such as when capturing content while charging Fusion, it might be useful to remove the side door to access the USB-C port.



**WARNING:** Remove the side door only when you are using the camera in a dry, dust-free environment. When the door is open or removed, the camera is not waterproof. Never operate the camera with the battery door open.

### REMOVING THE SIDE DOOR

1. Hold down the Latch Release button and slide the door open.
2. Pull the door off of the camera.

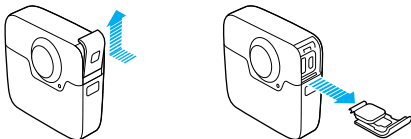

## REMOVING THE SIDE DOOR

---

### REATTACHING THE SIDE DOOR

1. Hold down the Latch Release button and extend the tab on the door.



2. Press the tab onto the small silver bar.

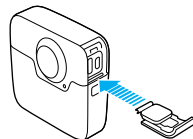

## MAINTENANCE

---

Follow these guidelines to get the best performance from your camera:

- Always store the camera in the Fusion Case when not in use. The lenses are exposed to capture spherical content and are unprotected. Scratches to the lenses are not covered under the warranty.
- To protect the lenses from damage, do not rest Fusion on its front or back side. Be sure the lenses are not resting against any surface.

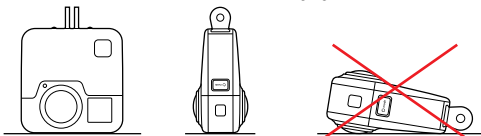

- To clean the lenses, wipe them with a soft, lint-free cloth. If debris becomes lodged between the lens and the trim ring, flush it out with water or air. Do not insert foreign objects around the lens.
- When Fusion is not in use, be sure to store it in the Fusion Case to protect the lenses from damage.
- The camera is waterproof to 16ft (5m)—no housing needed. Ensure that the doors are closed before using the camera in or around water, dirt, or sand.
- Before closing the doors, be sure the seals are free of debris. If needed, clean with a cloth.
- Before opening the doors, be sure the camera is free of water or debris. If needed, rinse the camera with fresh water and dry it with a cloth.

## MAINTENANCE

---

- If sand or debris hardens around the doors, soak the camera in warm tap water for 15 minutes and then rinse thoroughly to remove the debris before opening the doors.
- For best audio performance, shake the camera or blow on the mics to remove water and debris from the microphone holes. To prevent damage to the internal waterproof membranes, do not use compressed air to blow into the mic holes.
- After every use in salt water, rinse the camera with fresh water, and dry with a soft cloth.

## BATTERY INFORMATION

---

### MAXIMIZING BATTERY LIFE

A message appears on the status screen if the battery drops below 10%. If the battery reaches 0% while recording, the camera saves the file and powers off.

To maximize battery life, follow these guidelines when possible:

- Turn off Wireless
- Turn off GPS
- Turn off Protune
- Use *QuikCapture* (page 24)

### RECORDING WHILE CHARGING

Using the USB-C cable that came with your camera, you can capture video and photos while the camera is plugged in to a USB charging adapter, the GoPro Supercharger, another GoPro charger, or the GoPro Portable Power Pack. Although the battery does not charge during recording, you can use one of the above methods to power the camera and obtain extended recording time. When you stop recording, charging resumes. (You cannot record while charging the camera through a computer.)

**NOTICE:** Because the side door is open during charging, the camera is not waterproof in this situation.



**WARNING:** Using a wall charger other than a GoPro charging device can damage the GoPro camera battery and could result in fire or leakage. With the exception of the GoPro Supercharger (sold separately), only use chargers marked: Output 5V 1-3A. If you do not know the voltage and current of your charger, use the included USB cable to charge the camera from your computer.

## BATTERY INFORMATION

---

### BATTERY STORAGE AND HANDLING

The camera contains sensitive components, including the battery. Avoid exposing your camera to very cold or very hot temperatures. Low or high temperature conditions may temporarily shorten the battery life or cause the camera to temporarily stop working properly. Avoid dramatic changes in temperature or humidity when using the camera, as condensation may form on or within the camera.

Do not dry the camera or battery with an external heat source such as a microwave oven or hair dryer. Damage to the camera or battery caused by contact with liquid inside the camera is not covered under the warranty.

Do not store your battery with metal objects, such as coins, keys or necklaces. If the battery terminals come in contact with metal objects, this may cause a fire.

Do not make any unauthorized alterations to the camera. Doing so may compromise safety, regulatory compliance, performance, and may void the warranty.



**WARNING:** Do not drop, disassemble, open, crush, bend, deform, puncture, shred, microwave, incinerate or paint the camera or battery. Do not insert foreign objects into the battery opening on the camera. Do not use the camera or the battery if it has been damaged—for example, if cracked, punctured or harmed by water. Disassembling or puncturing the battery can cause an explosion or fire.

## BATTERY INFORMATION

---

### BATTERY DISPOSAL

Most rechargeable lithium-ion batteries are classified as non-hazardous waste and are safe for disposal in the normal municipal waste stream. Many localities have laws in place requiring battery recycling. Check your local laws to make sure that you can dispose of rechargeable batteries in your regular trash. To safely dispose of lithium-ion batteries, protect terminals from exposure to other metal with packing, masking or electrical tape so they do not cause a fire while being transported.

Lithium-ion batteries, however, do contain recyclable materials and are accepted for recycling by the Rechargeable Battery Recycling Corporation's (RBRC) Battery Recycling Program. We encourage you to visit Call2Recycle at [call2recycle.org](http://call2recycle.org) or call 1-800-BATTERY in North America to find a convenient recycling location.

Never dispose of a battery in a fire because it may explode.



**WARNING:** Only use manufacturer-recommended replacement batteries for your camera.

---

## TROUBLESHOOTING

---

### MY GOPRO WON'T POWER ON

Make sure your GoPro is charged. To charge your camera, use the included USB-C cable and a computer. You can also use GoPro's Supercharger or USB-compatible Wall Charger or Auto Charger (all sold separately) or any charging device marked with output 5V 1-3A.

### MY GOPRO WON'T RESPOND WHEN I PRESS A BUTTON

See [Restarting Your GoPro](#) (page 57).

### PLAYBACK ON MY COMPUTER IS CHOPPY

Choppy playback is typically not a problem with the file. If your footage skips, one of these situations is likely the cause:

- Using an incompatible video player. Not all video players support the H.264 codec. For best results, download the latest version of Fusion Studio for free at [gopro.com/apps](http://gopro.com/apps).
- The computer does not meet the minimum requirements for playback. The higher the resolution and frame rate of your video, the harder the computer has to work to play it back. Make sure that your computer meets the minimum requirements for the playback software.

### I FORGOT MY CAMERA'S USERNAME OR PASSWORD

See [Locating Your Camera's Username and Password](#) (page 14).

### I DON'T KNOW WHAT SOFTWARE VERSION I HAVE

Go to Preferences, then select About. For details, see [Locating Your Software Version](#) (page 14).

## TROUBLESHOOTING

---

### I CAN'T FIND MY CAMERA'S SERIAL NUMBER

The camera's serial number is listed in several places:

- In Preferences > About (the serial number automatically appears after the camera name and password)
- Next to the USB-C port
- On your camera's microSD card (in the version.txt file in the MSC folder)

### MY LENS IS DAMAGED

Contact Customer Support at [gopro.com/help](https://gopro.com/help) for details about where to send your camera for repair.

For more answers to commonly asked questions, see [gopro.com/help](https://gopro.com/help).

## CUSTOMER SUPPORT

---

GoPro is dedicated to providing the best possible service. To reach GoPro Customer Support, visit [gopro.com/help](https://gopro.com/help).

## TRADEMARKS

---

GoPro, HERO and their respective logos are trademarks or registered trademarks of GoPro, Inc. in the United States and other countries. © 2017 GoPro, Inc. All rights reserved. Made in China. Hecho en China. For patent information, visit [gopro.com/patents](https://gopro.com/patents). GoPro, Inc., 3000 Clearview Way, San Mateo CA 94402 | GoPro GmbH, Flossergasse 2, 81369 Munich, Germany

## REGULATORY INFORMATION

---

To see the complete list of country certifications, refer to the Important Product + Safety Instructions included with your camera or visit [gopro.com/help](https://gopro.com/help).

