

RICOH



Medium Format Digital SLR Camera

PENTAX 645Z

Menu Reference

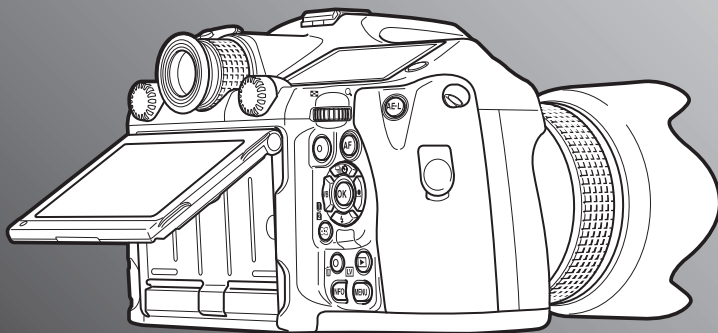

To ensure the best performance from your camera,
please read the operating manual before using the camera.

Thank you for purchasing our PENTAX 645Z medium format digital SLR camera. Please read this manual before using the camera in order to get the most out of all the features and functions. Keep this manual safe, as it can be a valuable tool in helping you to understand all the camera's capabilities.

Lenses you can use

In general, lenses that can be used with this camera are D FA645 and FA645 lenses, and 645 lenses that have an Aperture **A** (Auto) position. To use any other lens or accessory, see the Operating Manual (📖 p.28).

Regarding copyrights

Images taken with this camera that are for anything other than personal enjoyment cannot be used without permission according to the rights as specified in the Copyright Act. Please take care, as there are cases where limitations are placed on taking pictures even for personal enjoyment during demonstrations, performances or of items on display. Images taken with the purpose of obtaining copyrights also cannot be used outside the scope of use of the copyright as laid out in the Copyright Act, and care should be taken here also.

Trademarks

Microsoft, Windows and Windows Vista are registered trademarks of Microsoft Corporation in the United States of America and other countries. Macintosh, Mac OS, and QuickTime are trademarks of Apple Inc., registered in the U.S. and other countries.

Intel, Intel Core, and Pentium are trademarks of Intel Corporation in the U.S. and/or other countries.

SDXC Logo is a trademark of SD-3C, LLC.

Eye-Fi, the Eye-Fi logo and Eye-Fi *connected* are trademarks of Eye-Fi, Inc.

This product includes DNG technology under license by Adobe Systems Incorporated.

The DNG logo is either a registered trademark or trademark of Adobe Systems Incorporated in the United States and/or other countries.

HDMI, the HDMI logo and High-Definition Multimedia Interface are trademarks or registered trademarks of HDMI Licensing, LLC in the United States and/or other countries.

All other trademarks are the property of their respective owners.

This product supports PRINT Image Matching III. PRINT Image Matching enabled digital still cameras, printers and software help photographers to produce images more faithful to their intentions. Some functions are not available on printers that are not PRINT Image Matching III compliant.

Copyright 2001 Seiko Epson Corporation. All Rights Reserved. PRINT Image Matching is a trademark of Seiko Epson Corporation. The PRINT Image Matching logo is a trademark of Seiko Epson Corporation.

AVC Patent Portfolio License

This product is licensed under the AVC Patent Portfolio License for the personal use of a consumer or other uses in which it does not receive remuneration to (i) encode video in compliance with the AVC standard ("AVC video") and/or (ii) decode AVC video that was encoded by a consumer engaged in a personal activity and/or was obtained from a video provider licensed to provide AVC video. No license is granted or shall be implied for any other use.

Additional information may be obtained from MPEG LA, L.L.C. See <http://www.mpegla.com>.

To users of this camera

- Do not use or store this camera in the vicinity of equipment that generates strong electromagnetic radiation or magnetic fields. Strong static charges or the magnetic fields produced by equipment such as radio transmitters could interfere with the monitor, damage the stored data, or affect the camera's internal circuitry and cause camera misoperation.
- The liquid crystal panel used for the monitor is manufactured using extremely high precision technology. Although the level of functioning pixels is 99.99% or better, you should be aware that 0.01% or fewer of the pixels may not illuminate or may illuminate when they should not. However, this has no effect on the recorded image.
- In this manual, the generic term "computer(s)" refers to either a Windows PC or a Macintosh.
- In this manual, the term "battery(ies)" refers to any type of batteries used for this camera and its accessories.

There is a possibility that the illustrations and the display screen of the monitor in this manual are different from the actual ones.

Menu Reference Contents

Menu Descriptions and Default Settings **R5**

Rec. Mode Menu	R5
Movie Menu	R8
Playback Menu	R8
Set-up Menu	R9
Custom Setting Menu	R11
Other Default Settings	R13
How to Use the Menu	R14

Rec. Mode Menu **R15**

Exposure Mode	R15
Memory Card Options	R15
Image Capture Settings	R15
HDR Capture	R16
Lens Correction	R16
D-Range Settings	R16
ISO AUTO Setting	R17
High-ISO NR	R17
Slow Shutter Speed NR	R17
Program Line	R18
GPS	R18
Live View	R18
Electronic Level	R19

Instant Review	R19
Digital Preview	R19
E-Dial Programming	R20
Button Customization	R20
Memory	R22
Save USER Mode	R22

Movie Menu **R24**

Exposure Setting	R24
Memory Card Options	R24
Movie Capture Settings	R24
Recording Sound Level	R24
HDR Capture	R24
Movie SR	R25

Playback Menu **R26**

Slideshow	R26
Quick Zoom	R26
Grid Display	R26
Highlight Alert	R26
Auto Image Rotation	R26
Protect All Images	R26
Delete All Images	R27

Set-up Menu

Language/言語	R28
Date Adjustment	R28
World Time	R28
Text Size	R29
Sound Effects	R29
LCD Display	R30
LCD Display Settings	R30
USB Connection	R30
HDMI Out	R30
Folder Name	R31
Create New Folder	R32
File Name	R32
File No.	R33
Copyright Information	R33
Flicker Reduction	R34
Auto Power Off	R34
Wireless Memory Card	R34
Reset	R35
Pixel Mapping	R35
Dust Alert	R36
Dust Removal	R37
Sensor Cleaning	R37
Format	R38
Firmware Info/Options	R38

R28

C Custom Setting Menu

1. EV Steps	R39
2. Sensitivity Steps	R39
3. Meter Operating Time	R39
4. AE-L with AF Locked	R39
5. Link AE and AF Point	R39
6. Auto EV Compensation	R39
7. Bulb (B) Mode Options	R39
8. Bracketing Order	R40
9. One-Push Bracketing	R40
10. WB Adjustable Range	R40
11. WB When Using Flash	R40
12. AWB in Tungsten Light	R40
13. Color Temperature Steps	R40
14. Superimpose AF Area	R40
15. AF.S Setting	R40
16. 1st Frame Action in AF.C	R41
17. Action in AF.C Continuous	R41
18. Hold AF Status	R41
19. AF with Remote Control	R41
20. Color Space	R41
21. LCD Panel Illumination	R41
22. Save Rotation Info	R41
23. Save Menu Location	R41
24. AF Fine Adjustment	R42
25. Flash Sync Speed	R42
26. 4-way Controller Options	R42
27. Mirror Up Operation	R42

R39

28. Shake Reduction Options	R43
29. Enable/Disable Controls	R43
Reset Custom Functions	R43

Appendix

R44

Restrictions on the Combinations of Special Functions	R44
Main Specifications	R45
Index	R50
WARRANTY POLICY	R55

Regarding User Registration



In order to better serve you, we request that you complete the user registration, which can be found on the CD-ROM supplied with the camera (📖 p.91) or on our website.











Thank you for your cooperation.

Menu Descriptions and Default Settings

Rec. Mode Menu

Menu	Item	Function	Default Setting	Page	
📷1	Exposure Mode *1	Temporarily changes the exposure mode when the mode dial is set to U1 , U2 or U3 .	P	p.R15	
	Memory Card Options *2	Sets the recording method for when two memory cards are inserted.	Sequential Use	p.R15	
	Image Capture Settings	File Format *2	Sets the file format of images.	JPEG	p.R15
		JPEG Recorded Pixels *2	Sets the recording size of images saved in JPEG format.	<input type="checkbox"/>	
		JPEG Quality *2	Sets the quality of images saved in JPEG format.	★★★	
		RAW File Format	Sets the RAW file format.	PEF	
		180° Rotation Info	Rotates the image 180° and saves the rotated image.	Off	
	HDR Capture	HDR Capture *2	Sets the type of high dynamic range shooting.	Off	p.R16
		Exposure Bracket Value *2	Sets the range in which to change the exposure.	±2EV	
		Auto Align	Sets whether to automatically adjust the composition.	On	
	Lens Correction	Distortion Correction *2	Reduces distortions occurring due to lens properties.	Off	p.R16
		Lat-Chromatic-Ab Adj *2	Reduces lateral chromatic aberrations occurring due to lens properties.	On	
Peripheral Illumin. Corr. *2		Reduces peripheral light fall-off occurring due to lens properties.	Off		
Diffraction Correction *2		Corrects the diffraction when the aperture is small.	On		
📷2	D-Range Settings *2	Expands the dynamic range and prevents bright and dark areas from occurring.	Auto/Auto	p.R16	
	ISO AUTO Setting *2	Sets the range of automatic correction in ISO AUTO and the manner in which the sensitivity is increased.	ISO 100 to ISO 3200/Standard	p.R17	
	High-ISO NR *2	Sets the Noise Reduction setting when shooting with a high ISO sensitivity.	Auto	p.R17	
	Slow Shutter Speed NR *2	Sets the Noise Reduction setting when shooting with a slow shutter speed.	Auto	p.R17	
	Program Line	Selects the program line.	Normal	p.R18	
	GPS	Sets the camera action for when the optional GPS unit is used.	–	p.R18	



Menu	Item	Function	Default Setting	Page		
 3	Live View	Contrast AF *2	Sets the AF Mode for shooting with Live View.	Face Detection	p.R18	
		Focus Peaking *2	Emphasizes the outline of the subject in focus and makes it easier to check the focus.	Off		
		Grid Display	Displays the grid during Live View.	Off		
		Histogram Display	Displays the histogram during Live View.	Off		
		Highlight Alert	Bright (overexposed) areas blink red during Live View.	Off		
	Electronic Level	Rotate Display 180°	Rotates the image 180° and displays the rotated image.	Off	p.R19	
		Viewfinder	Displays the electronic level on the EV bar scale in the viewfinder and/or LCD panel.	Off		
	 4	Instant Review	Live View	Displays the electronic level during Live View.	On	p.R19
Display Time			Sets the Instant Review display time.	1sec.		
Zoom Instant Review			Sets whether to display a magnified image during Instant Review.	On		
Save RAW Data			Sets whether to save the RAW image during Instant Review.	On		
Delete			Sets whether to delete the image during Instant Review.	On		
Digital Preview		Histogram Display	Displays the histogram during Instant Review.	Off	p.R19	
		Highlight Alert	Bright (overexposed) areas blink red during Instant Review.	Off		
		Zoom Instant Review	Sets whether to display a magnified image during Digital Preview.	On		
		Save Preview Image	Sets whether to enable saving a preview image.	On		
	Histogram Display	Displays the histogram during Digital Preview.	Off			
	Highlight Alert	Bright (overexposed) areas blink red during Digital Preview.	Off			

Menu	Item	Function	Default Setting	Page	
 4	E-Dial Programming	P	Tv, Av, ➡P	p.R20	
		Sv	-, ISO, -		
		Tv	Tv , -, -		
		Av	-, Av , -		
		TAv	Tv , Av , PLINE		
		M	Tv , Av , PLINE		
		B	-, Av , -		
		X	-, Av , -		
		 RAW	-, -, -		
		 Av	-, Av , PLINE		
		 Av	Tv , Av , PLINE		
		 Av	Tv , Av , PLINE		
	Rotation Direction	Reverses the effect obtained when  or  is turned.	Rotate Right		
	Button Customization	RAW/Fx Button	Sets the  operation.	One Push File Format	p.R20
		AF Button	Sets the  operation.	Enable AF1	
Preview Dial		Sets the camera action for when the main switch is turned to the  position.	Optical Preview		
Illumination Button		Sets the  operation.	LCD Panel Illumination		
Memory		Determines which settings to save when the power is turned off.	On for settings other than [HDR Capture]	p.R22	
Save USER Mode		You can save frequently used capture settings to U1 , U2 or U3 of the mode dial.	-	p.R22	

*1 Appears only when the mode dial is set to **U1**, **U2** or **U3**.

*2 Can also be set from the control panel.

Movie Menu



Menu	Item	Function	Default Setting	Page
 1	Exposure Setting *1	Sets the exposure mode for  mode.	Program AE	p.R24
	Memory Card Options *1	Selects one of memory cards inserted in SD1 and SD2 slots for recording movies.	SD1	p.R24
	Movie Capture Settings *1	Sets the number of recorded pixels and framerate.	 /30p	p.R24
	Recording Sound Level *1	Sets the Recording Sound Level and the volume level for recording.	Auto	p.R24
	HDR Capture *1	Sets the type of high dynamic range shooting when the drive mode is set to [Interval Movie Record].	Off/±2EV	p.R24
	Movie SR *1	Activates the Movie Shake Reduction function.	On	p.R25

*1 Can also be set from the control panel.

Playback Menu

Menu	Item	Function	Default Setting	Page
 1	Slideshow	Display Duration	3sec.	p.R26
		Screen Effect	Off	
		Repeat Playback	Off	
		Auto Movie Playback	On	
	Quick Zoom	Sets the initial magnification when magnifying images.	Off	p.R26
	Grid Display	Sets the grid style and color.	Off/Translucent black color	p.R26
	Highlight Alert	Bright (overexposed) portions blink red in Standard Information Display or Histogram Display in playback mode.	Off	p.R26
	Auto Image Rotation	Images are rotated when playing back images captured with the camera held vertically or images for which the rotation information has been changed.	On	p.R26
	Protect All Images	Protects all images stored in the memory card at once.	–	p.R26
	Delete All Images	Deletes all images stored in the memory card at once.	–	p.R27

Menu	Item	Function	Default Setting	Page	
1	Language/言語	Changes the display language.	English	p.R28	
	Date Adjustment	Sets the date and time or display format.	01/01/2014	p.R28	
	World Time	Switches between the date and time display of your hometown city and that of a specified city.	Hometown	p.R28	
	Text Size	Sets whether to magnify the text size when selecting a menu.	Standard	p.R29	
	Sound Effects	Switches the operation sound on/off and changes the volume for In-focus, AE-L, Self-timer, Remote Control, Mirror Up, Change AF Point, and the RAW/Fx button.	Volume 3/ All On	p.R29	
	LCD Display	Guide Display	Sets whether to display the operation guides when the exposure mode is changed.	On	p.R30
		Auto Screen Rotation	Sets whether to display the status screen and control panel vertically if the camera is held vertically.	On	
		Display Color	Sets the display color of the status screen, control panel, and menu cursor.	1	
LCD Display Settings		Adjusts the brightness, saturation and the color of the monitor.	0	p.R30	
2	USB Connection		Sets the USB connection mode when connecting to a computer.	MSC	p.R30
	HDMI Out		Sets the output format when connecting to an AV device with an HDMI input terminal.	Auto	p.R30
	Folder Name		Sets the folder name in which images are stored.	Date	p.R31
	Create New Folder		Creates a new folder on the memory card.	–	p.R32
	File Name		Sets the file name assigned to an image.	IMGP/_IMG	p.R32
	File No.	Sequential Numbering	Sets whether to continue the sequential numbering for the file name when a new folder is created.	On	p.R33
		Reset File Number	Resets the file number setting, and returns to 0001 each time a new folder is created.	–	
	Copyright Information		Sets the photographer and copyright information embedded in Exif.	Off	p.R33

Menu	Item	Function	Default Setting	Page
3	Flicker Reduction	Cuts down on the screen flicker by setting the power frequency.	50Hz	p.R34
	Auto Power Off	Sets the time until the camera turns off automatically if no operations are made for a certain period of time.	1min.	p.R34
	Wireless Memory Card	Sets the camera action for when an Eye-Fi card or a Flucard is used.	Auto/On	p.R34
	Reset	Resets the settings of the direct keys and for the items of the  menu,  menu,  menu, control panel, and playback mode palette.	–	p.R35
4	Pixel Mapping	Maps out and corrects any defective pixels on the CMOS sensor.	–	p.R35
	Dust Alert	Detects dust adhering to the CMOS sensor and visually displays the location of the dust on the monitor.	–	p.R36
	Dust Removal	Cleans the CMOS sensor by shaking it.	On	p.R37
	Sensor Cleaning	Locks the mirror in the up position for cleaning the CMOS sensor with a blower.	–	p.R37
	Format	Formats a memory card.	–	p.R38
	Firmware Info/Options	Displays the camera's firmware version.	–	p.R38





Custom Setting Menu

Menu	Item	Function	Default Setting	Page
C1	1. EV Steps	Sets the adjustment steps for exposure.	1/3 EV Steps	p.R39
	2. Sensitivity Steps	Sets the adjustment steps for ISO sensitivity.	1 EV Step	p.R39
	3. Meter Operating Time	Sets the meter operating time.	10sec.	p.R39
	4. AE-L with AF Locked	Sets whether to lock the exposure value when the focus is locked.	Off	p.R39
	5. Link AE and AF Point	Sets whether to link the exposure and AF point in the focusing area.	Off	p.R39
	6. Auto EV Compensation	Sets whether to automatically compensate when the proper exposure cannot be determined.	Off	p.R39
	7. Bulb (B) Mode Options	Sets the camera operation when pressing the shutter release button in B mode.	Type1	p.R39
C2	8. Bracketing Order	Sets the order for Exposure Bracketing shooting.	0 - +	p.R40
	9. One-Push Bracketing	Sets whether to shoot all frames with one release when using Exposure Bracketing.	Off	p.R40
	10. WB Adjustable Range	Sets whether to automatically fine-tune the white balance when the light source is specified for the white balance setting.	Fixed	p.R40
	11. WB When Using Flash	Sets the white balance setting for when using flash.	Auto White Balance	p.R40
	12. AWB in Tungsten Light	Sets the tungsten light color tone for when the white balance is set to [Auto White Balance].	Subtle Correction	p.R40
	13. Color Temperature Steps	Sets the adjustment steps for color temperature.	Kelvin	p.R40
	14. Superimpose AF Area	Sets whether to display the active AF point in red in the viewfinder.	On	p.R40













Menu	Item	Function	Default Setting	Page
C3	15. AF.S Setting	Sets the action priority for when the focus mode is set to AF.S and the shutter release button is fully pressed.	Focus-priority	p.R40
	16. 1st Frame Action in AF.C	Sets the action priority for the first frame when the focus mode is set to AF.C and the shutter release button is fully pressed.	Release-priority	p.R41
	17. Action in AF.C Continuous	Sets the action priority during continuous shooting when the focus mode is set to AF.C .	Focus-priority	p.R41
	18. Hold AF Status	Sets whether to maintain the focus for a certain amount of time when the subject happens to move out of the selected focusing area after being focused.	Off	p.R41
	19. AF with Remote Control	Sets whether to use autofocus when shooting with a remote control unit.	Off	p.R41
	20. Color Space	Sets the color space to use.	sRGB	p.R41
	21. LCD Panel Illumination	Sets the brightness of the LCD panel.	Low	p.R41
C4	22. Save Rotation Info	Sets whether to save rotation information when shooting.	On	p.R41
	23. Save Menu Location	The last menu tab displayed on the monitor is saved, and it is displayed again the next time MENU is pressed.	Reset Menu Location	p.R41
	24. AF Fine Adjustment	Allows you to precisely fine tune your lenses with the camera's autofocus system.	Off	p.R42
	25. Flash Sync Speed	Selects the flash sync speed.	1/125	p.R42
	26. 4-way Controller Options	Selects the ▲▼◀▶ operations for when the focusing area selection mode is set to one of the "Select" type modes.	Type1	p.R42
	27. Mirror Up Operation	Enables or disables the Mirror Up dial.	On	p.R42
	28. Shake Reduction Options	Select whether to perform Shake Reduction only when shooting or when the shutter release button is pressed halfway.	Type1	p.R43
C5	29. Enable/Disable Controls	Enables or disables operation of the selected group of buttons and dials using Lock .	Type1	p.R43
	Reset Custom Functions	Resets all the settings of the Custom Setting menu to the defaults.	–	p.R43

Other Default Settings

Direct Keys

Item	Default Setting	Page
Flash Mode	Flash On	 p.64
Custom Image	Natural	 p.68
Drive Mode	Single Frame Shooting	 p.56
White Balance	Auto White Balance	 p.53

Playback Mode Palette

Item	Default Setting	Page
Image Rotation	–	 p.76
Digital Filter	Base Parameter Adj	 p.79
Color Moiré Correction	–	 p.78
Resize	Maximum size according to the setting	 p.77
Cropping	Maximum size according to the setting	 p.78
Protect	–	 p.83
Slideshow	–	 p.76
Save as Manual WB	–	 p.54
Save Cross Processing	–	 p.69
RAW Development	File Format: JPEG JPEG Recorded Pixels: <input type="checkbox"/> JPEG Quality: ★★★	 p.82
Movie Edit	–	 p.81
Image Copy	–	 p.77
Eye-Fi Image Transfer	–	p.R34

How to Use the Menu

Example: when setting [Slow Shutter Speed NR]

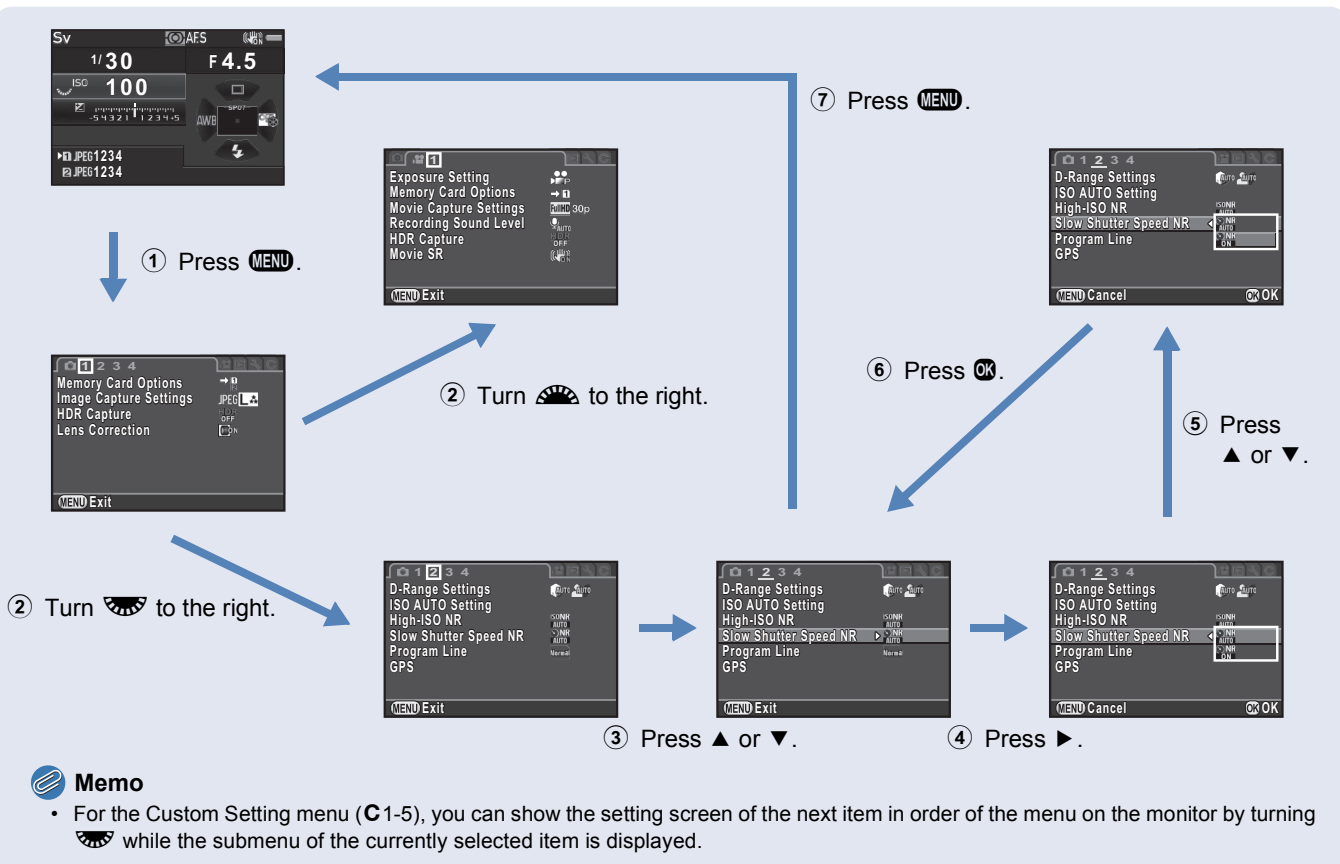

Rec. Mode Menu

Memo

- Functions with the control panel icon  next to the menu icon and number in the right end of the title bar can also be set from the control panel.

Exposure Mode



Switches between the exposure modes temporarily when the mode dial is set to **U1**, **U2** or **U3**.

Memo

- When the camera is turned off, the exposure mode set here reverts to the previously-saved one.
- Refer to “Save USER Mode” (p.R22) for saving the desired settings to **U1**, **U2** and **U3**.

Memory Card Options

Sets the recording method for when two memory cards are inserted.

 Sequential Use	When the memory card in SD1 slot becomes full, data is saved to the card in SD2.
 Save to Both	Saves the same data to the memory cards in both SD1 and SD2.
 Separate RAW/JPEG	Saves the RAW data to the memory card in SD1, and JPEG data to the card in SD2.

Memo



- When in  mode, data is saved to the card in either SD1 or SD2. It can be set in the  1 menu. (p.R24)

Image Capture Settings

Sets the file format for still pictures.

File Format	JPEG, RAW, RAW+, TIFF
JPEG Recorded Pixels	<input type="checkbox"/> L, <input type="checkbox"/> M, <input type="checkbox"/> S, <input type="checkbox"/> XS
JPEG Quality	★★★, ★★, ★
RAW File Format	PEF, DNG
180° Rotation Info	<input type="checkbox"/> , <input checked="" type="checkbox"/>

Caution

- When [Memory Card Options] of the  1 menu is set to [Separate RAW/JPEG], [File Format] is fixed to [RAW+].

Memo

- When [File Format] is set to [RAW+], a JPEG image and a RAW image with the same file number are saved at the same time.
- You can take pictures with a different file format setting only when **RAW** is pressed. (p.R21)
- [PEF] of [RAW File Format] is a PENTAX original RAW file format.
- When [180° Rotation Info] is set to on,  appears on the status screen and Live View screen.

● Number of recorded pixels and pixel resolution for JPEG files

	Recorded Pixels	Pixels
<input type="checkbox"/> L	51M	8256×6192
<input type="checkbox"/> M	36M	6912×5184
<input type="checkbox"/> S	21M	5376×4032
<input type="checkbox"/> XS	3M	1920×1440

HDR Capture



Takes three consecutive images at three different exposure levels to create a single composite picture with them.

1 Select [HDR Capture] in 1 menu and press .

The [HDR Capture] screen appears.

2 Select [HDR AUTO], [HDR 1], [HDR 2] or [HDR 3], and press .

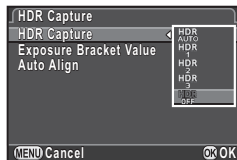

3 Set the range in which to change the exposure in [Exposure Bracket Value].

Select from ± 1 , ± 2 , or ± 3 .

4 Set whether to use Auto Align or not.

<input checked="" type="checkbox"/>	Uses Auto Align.
<input type="checkbox"/>	Does not use Auto Align. The Shake Reduction function on the lens is disabled.

5 Press twice.

The camera returns to standby mode.

Caution

- HDR Capture is not available in **B** or **X** mode.
- This function cannot be used in combination with some other functions. (p.R44)
- When the drive mode is set to [Interval Shooting], [Auto Align] is fixed to off.
- For HDR Capture, multiple images are combined together to create a single image, so it will take time to save the image.

Lens Correction



The following features are available.

Distortion Correction	Reduces distortions occurring due to lens properties.
Lat-Chromatic-Ab Adj	Reduces lateral chromatic aberrations occurring due to lens properties.
Peripheral Illumin. Corr.	Reduces peripheral light fall-off occurring due to lens properties.
Diffraction Correction	Corrects the diffraction when the aperture is small.

Memo

- Corrections can only be made when a D FA645 or FA645 lens is attached to the camera. (p.28) The features are disabled when using an accessory such as a rear converter that is attached between the camera and the lens.
- For RAW images, correction information is saved as a RAW file parameter and you can select whether to apply the correction to the images when developing them. For the RAW Development function, [Color Fringe Correction] can also be set. (p.82)

D-Range Settings



Expands the dynamic range and enables a wider range of tones by the CMOS sensor and reduces the occurrence of overexposed/underexposed areas. Set [Highlight Correction] to [AUTO], [ON], or [OFF], and set [Shadow Correction] to [AUTO], [Low], [Medium], [High] or [OFF].

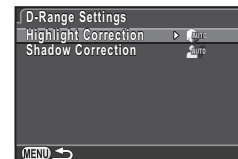

ISO AUTO Setting



Sets the range in which the sensitivity is automatically adjusted when the sensitivity is set to ISO AUTO.

The manner in which the sensitivity is increased can be specified in [AUTO ISO Parameters].

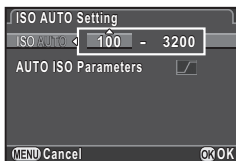

<input type="checkbox"/> Slow	Increases the sensitivity as little as possible.
<input checked="" type="checkbox"/> Standard	(Default setting)
<input checked="" type="checkbox"/> Fast	Actively increases the sensitivity.

Memo

- When [HDR Capture] of the 1 menu is set and [Auto Align] is set to on, [AUTO ISO Parameters] is fixed to [Fast].

High-ISO NR



Sets the Noise Reduction setting when shooting with a high ISO sensitivity.

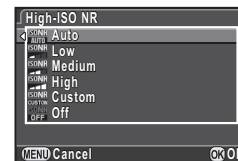

Auto	Applies Noise Reduction at optimally calculated levels throughout ISO range.
Low/Medium/High	Applies Noise Reduction at constant chosen level throughout ISO range.
Custom	Applies Noise Reduction at user-defined levels for each ISO setting.
Off	Does not apply Noise Reduction at any ISO setting.

When [Custom] is selected, select [Setting] and set the noise reduction level according to the ISO sensitivity.

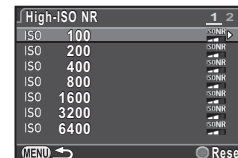

Slow Shutter Speed NR



Sets how the Noise Reduction function works during long exposures.

AUTO	The camera determines the camera conditions, such as the shutter speed, sensitivity, and internal temperature, and reduces noise as necessary.
ON	Reduces noise at shutter speed of 1 second or slower.



Program Line



In [E-Dial Programming] of the menu, you can specify how exposure is controlled when [P LINE] is selected (p.R20) for the button operation.

	Auto	The camera determines the appropriate settings.
	Normal	Basic program automatic exposure.
	Hi-speed priority	Prioritizes high shutter speeds.
	DOF priority (deep)	Closes the aperture for a deep depth of field.
	DOF priority (shallow)	Opens the aperture for a shallow depth of field.
	MTF priority	Prioritizes the optimum aperture setting of the attached lens when a A645, FA645, or D FA645 lens is used.

GPS



The following functions are available when the optional GPS unit O-GPS1 is attached to this camera.

Electronic Compass	Displays the current latitude, longitude, altitude, direction, and Coordinated Universal Time (UTC).	
GPS Time Sync	Automatically adjusts the camera's date and time settings using information acquired from GPS satellites.	

Memo

- Refer to the manual of the GPS unit for details on how to attach the unit and information on the unit's functions.
- To display [Electronic Compass], refer to "Shooting Info Display" (p.18).

Caution

- Simple Navigation and ASTROTRACER cannot be used with this camera.

Live View



Sets the focus settings and display settings for shooting with Live View.



Contrast AF

You can select an autofocus mode when shooting with Live View. The setting can also be changed by turning while pressing during Live View. (p.46)

Focus Peaking

When [Focus Peaking] is set to on, the outline of the subject in focus is emphasized and makes it easier to check the focus. This function works in both **AF** and **MF** modes.

Other Display Settings

Grid Display	Grid Style	4×4, Golden Section, Scale, Square 1, Square 2, OFF
	Grid Color	Translucent black color, Translucent white color
Histogram Display		Displays the histogram.
Highlight Alert		Bright (overexposed) areas blink red.
Rotate Display 180°		Displays the Live View image rotated 180°.

Memo

- Even if [Rotate Display 180°] is set to on, the original, unrotated version of the image is saved. To save the rotated image, set [180° Rotation Info] in [Image Capture Settings] of the  1 menu. (p.R15)



Electronic Level

Sets whether to display the electronic level in the viewfinder and/or on the monitor during Live View.

Viewfinder	The horizontal tilt is displayed on the EV bar scale in the viewfinder and on the LCD panel in increments of 0.5° (up to 4.5°).
Live View	On the Live View screen, the horizontal tilt is displayed at the top of the screen and the vertical tilt on right side of the screen, both in increments of 0.5° (up to 9.5°).



Instant Review

Sets the operation and display settings during Instant Review. The following settings are available.

Display Time	Selects the Instant Review display time from [1sec.], [3sec.], [5sec.], [HOLD] and [Off]. When [HOLD] is selected, Instant Review will be displayed until the next operation.
Zoom Instant Review	Sets whether to magnify the image using  .
Save RAW Data	Sets whether to save the RAW image using  when the data is available.
Delete	Deletes the image when  is pressed.
Histogram Display	Displays the histogram.
Highlight Alert	Sets bright (overexposed) areas to blink red.

Digital Preview

Sets the operation and display settings during Digital Preview.

Zoom Instant Review	Sets whether to magnify the image using  .
Save Preview Image	Sets whether to save the preview image using  .
Histogram Display	Displays the histogram.
Highlight Alert	Sets bright (overexposed) areas to blink red.

Memo

- Refer to the “Operating Manual” for details on preview operations. ( p.67)

E-Dial Programming



For each exposure mode, you can select the parameters for when and are turned and is pressed.

- 1 Select [E-Dial Programming] in 4 menu and press .

The [E-Dial Programming] screen appears.

- 2 Select an exposure mode and press .

The screen for the selected exposure mode appears.

- 3 Select the desired setting for each exposure mode and press .

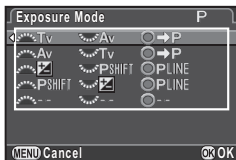

Tv	Change Shutter Speed
Av	Change Aperture Value
ISO	Change Sensitivity
	EV Compensation
	Return to P Mode
PSHIFT	Program Shift
PLINE	Program Line
--	Not available

- 4 Press .

The [E-Dial Programming] screen reappears.
Repeat Steps 2 to 4.

- 5 Press twice.

Memo

- If you select [Rotation Direction] in Step 2, you can reverse the effect obtained by turning or .

Button Customization



You can set the functions for when , or is pressed, or when the main switch is turned to .

- 1 Select [Button Customization] in 4 menu and press .

The [Button Customization] screen appears.

- 2 Select the item to set and press .

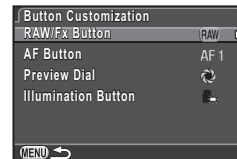

The screen to set the function for the selected item is displayed.



- 3 Select a function and press .

The following functions can be assigned to each button.

	Setting	Function	Page
RAW/Fx Button	One Push File Format	Temporarily changes the file format.	p.R21
	Optical Preview	Activates the Optical Preview.	p.67
	Digital Preview	Activates the Digital Preview.	
AF Button	Enable AF1	Autofocus is performed when is pressed.	p.44
	Enable AF2	Autofocus is performed when is pressed and not when the shutter release button is pressed halfway.	
	Cancel AF	While is pressed, autofocus is not performed even when the shutter release button is pressed halfway.	

	Setting	Function	Page
Preview Dial	Optical Preview	Activates the Optical Preview.	📖 p.67
	Digital Preview	Activates the Digital Preview.	
Illumination Button	LCD Panel Illumination	Turns the LCD panel illumination on when  is pressed.	📖 p.23
	Modeling Flash	Discharges the flash in Modeling Flash mode when a flash is connected and  is pressed.	📖 p.64
	Test Flash	Discharges the flash in Test Flash mode when a flash is connected and  is pressed.	

4 Press **MENU**.

The [Button Customization] screen reappears.
Repeat Steps 2 to 4.

5 Press **MENU** twice.

One Push File Format

- 1 Set [RAW/Fx Button] to [One Push File Format] in Step 3 of “Button Customization” (p.R20).
- 2 Select or for [Cancel after 1 shot].

<input checked="" type="checkbox"/>	The recording format returns to the [File Format] setting of [Image Capture Settings] in the  1 menu after a picture is taken.
<input type="checkbox"/>	The setting is retained until any of the following operations is performed: <ul style="list-style-type: none"> • When RAW is pressed again • When DISP, MENU or INFO is pressed, or when the mode dial or main switch is turned

- 3 Select the file format when **RAW** is pressed.

The left side is the [File Format] setting and the right side is the changed file format when **RAW** is pressed.

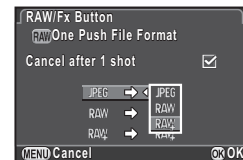

Caution

- The One Push File Format function cannot be used when [Memory Card Options] is set to [Separate RAW/JPEG] in the  1 menu. (p.R15)



Memory



Most of the functions set on this camera are saved even if the camera is turned off. For the following function settings, you can select whether to save the settings (☑) or to return the settings to their default values (☐) when the camera is turned off.

- Flash Mode
- Drive Mode
- White Balance
- Custom Image
- Sensitivity
- EV Compensation
- Flash Exposure Compensation
- Exposure Bracketing
- HDR Capture
- Playback Info Display
- Enable/Disable Controls

⚠ Caution

- [Memory] cannot be selected when the mode dial is set to **U1**, **U2**, or **U3**.

📎 Memo

- If [Playback Info Display] is set to off, the [Standard Information Display] always appears first when the camera is turned on. (📖 p.19)
- When [Reset] of the **3** menu is performed, all Memory settings return to the default values. (p.R35)

Save USER Mode



Camera settings can be saved to **U1**, **U2**, and **U3** of the mode dial and used repeatedly.

The following settings can be saved.

- Exposure Mode (except for **☑**)
- Sensitivity
- EV Compensation
- Metering mode
- AF point
- Flash Mode
- Drive Mode
- White Balance
- Custom Image
- **4**-1-4 menu settings (with exceptions)
- **C**1-5 menu settings (with exceptions)

Save Settings

- 1 Set all of the settings to save on the camera.**
- 2 Select [Save USER Mode] in **4** menu and press **▶**.**
The [Save USER Mode] screen appears.
- 3 Select [Save Settings] and press **▶**.**
The [Save Settings] screen appears.
- 4 Select [USER1], [USER2] or [USER3], and press **▶**.**
- 5 Select [Save] and press **OK**.**
The [Save Settings] screen reappears.



Memo

- The settings saved as the USER mode can be displayed on the monitor when you select [Check Saved Settings] in Step 3.
- To reset the settings to the default values, select [Reset USER Mode] in Step 3.

Rename USER Mode

You can change the name of the USER mode in which you saved settings.

1 Select [Rename USER Mode] in Step 3 of “Save Settings” and press ►.

The [Rename USER Mode] screen appears.

2 Select [USER1], [USER2] or [USER3], and press ►.

The text-entry screen appears.

3 Change the text.





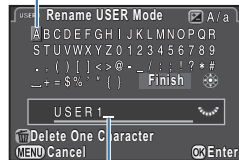



Up to 18 single-byte alphanumeric characters and symbols can be entered.

Text selection cursor



Text input cursor

Available operations

   	Moves the text selection cursor.
	Moves the text input cursor.
	Switches between upper and lower case letters.
	Enters a character selected with the text selection cursor at the position of the text input cursor.
	Deletes a character at the position of the text input cursor.

4 After entering the text, move the text selection cursor to [Finish], and press OK.

The [Rename USER Mode] screen reappears.

Using the Saved USER Mode

1 Set the mode dial to U1, U2 or U3.

The USER mode guide is displayed for 30 seconds.

Use ▲▼ to check the saved settings.



2 Change the settings as necessary.

The exposure mode can be changed in [Exposure Mode] of the  1 menu.

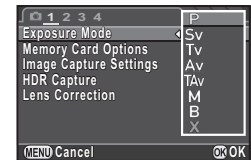

Memo

- The settings changed in Step 2 are not saved as the USER mode settings. When the camera is turned off, the settings return to the originally saved ones. To change the original settings, save the USER mode settings again.







Movie Menu

Memo

- Functions with the control panel icon  next to the menu icon and number in the right end of the title bar can also be set from the control panel.

Exposure Setting



Selects the exposure mode for  mode from , , , or .

Memory Card Options



Selects one of memory cards inserted in SD1 and SD2 slots for recording movies.



Caution

- When in  mode, data is saved only to the memory card in the selected slot. You cannot record movies when the memory card in the selected slot is full.

Movie Capture Settings



Sets the file format for movies.

Recorded Pixels	Framerate
	60i, 50i, 30p, 25p, 24p
	60p, 50p, 30p, 25p, 24p

Recording Sound Level



Select from [Auto], [Manual], or [Mute] for the movie recording volume. When [Manual] is selected, set the volume from 0 to 20.

Memo

- When [Manual] is set, a bar graph indicating the microphone volume level appears on the both sides of the Live View screen.

HDR Capture



High dynamic range shooting is available when the drive mode is set to [Interval Movie Record] ( p.61).

1 Select [HDR Capture] in 1 menu and press .

The [HDR Capture] screen appears.

2 Select [HDR AUTO], [HDR 1], [HDR 2] or [HDR 3], and press .

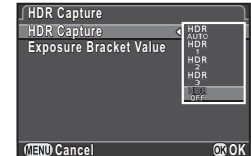

3 Set the range in which to change the exposure in [Exposure Bracket Value].

Select from ± 1 , ± 2 , or ± 3 .

4 Press twice.

The camera returns to standby mode.

 **Caution**

- When the drive mode is not set to [Interval Movie Record], this function is not available.

Movie SR



Activates the Movie Shake Reduction function.



▶ Playback Menu

Slideshow



Select the memory card in either the SD1 or SD2 slot, and set how to display images during slideshow. Select [Start] to start slideshow playback.

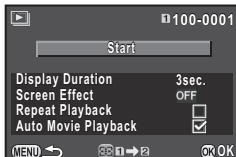

Item	Description	Setting
Display Duration	Sets an image display interval.	3sec., 5sec., 10sec., 30sec.
Screen Effect	Sets a transition effect when the next image is displayed	Fade, Wipe, Stripe, OFF
Repeat Playback	Sets whether the slideshow will start again from the beginning after the last image is displayed.	<input type="checkbox"/> , <input checked="" type="checkbox"/>
Auto Movie Playback	Plays back movies during the slideshow.	<input checked="" type="checkbox"/> , <input type="checkbox"/>

Press **DISP** (**1/2**) to switch between the memory cards inserted in the two slots, SD1 and SD2.

📌 Memo

- Refer to the “Operating Manual” for details on operations during slideshow playback. (📖 p.76)

Quick Zoom



Sets the initial magnification when magnifying images (📖 p.73). Select from **100%** (actual pixel size), [**×16**], [**×8**], [**×4**], [**×2**], and [Off].

Grid Display



You can display the grid in [Standard Information Display] or [No Information Display] in playback mode. Select from the following grid styles and colors.

Grid Style	4×4, Golden Section, Scale, Square 1, Square 2, OFF
Grid Color	Translucent black color, translucent white color

📌 Memo

- The grid cannot be displayed while viewing a movie, displaying a magnified image, or vertically displaying an image with its size reduced.

Highlight Alert



Bright (overexposed) portions blink red in Standard Information Display, Histogram Display, or No Information Display in playback mode.

Auto Image Rotation



Images are rotated and displayed according to the orientation of the camera when playing back images captured with the camera held vertically or images for which the rotation information has been changed.

Protect All Images



You can select the memory card in the SD1 or SD2 slot and protect all saved images at once. Select [Unprotect] to remove protection from all images.



Delete All Images



You can select the memory card in the SD1 or SD2 slot and delete all saved images at once.
When there are images with protection set, select [Delete all] or [Leave all].



Set-up Menu

Language/言語

You can change the language in which the menus, error messages, etc. are displayed.

Date Adjustment

You can change the date and time set at the initial setting ( p.35). You can also set the display format.

	Display Format
Date	mm/dd/yy, dd/mm/yy, yy/mm/dd
Time	12h, 24h



World Time

The date and time set at the initial setting ( p.34) serve as the date and time of your present location and are reflected in the shooting date and time for images.

Setting the destination to a location other than your present location enables you to display the local date and time on the monitor when traveling abroad and also save images time-stamped with the local date and time.

You can select from following cities for the hometown and destination.

Region	City
North America	Honolulu, Anchorage, Vancouver, San Francisco, Los Angeles, Calgary, Denver, Chicago, Miami, Toronto, New York, Halifax
Central and South America	Mexico City, Lima, Santiago, Caracas, Buenos Aires, Sao Paulo, Rio de Janeiro
Europe	Lisbon, Madrid, London, Paris, Amsterdam, Milan, Rome, Copenhagen, Berlin, Prague, Stockholm, Budapest, Warsaw, Athens, Helsinki, Moscow
Africa/ West Asia	Dakar, Algiers, Johannesburg, Istanbul, Cairo, Jerusalem, Nairobi, Jeddah, Tehran, Dubai, Karachi, Kabul, Male, Delhi, Colombo, Kathmandu, Dacca
East Asia	Yangon, Bangkok, Kuala Lumpur, Vientiane, Singapore, Phnom Penh, Ho chi Minh, Jakarta, Hong Kong, Beijing, Shanghai, Manila, Taipei, Seoul, Tokyo, Guam
Oceania	Perth, Adelaide, Sydney, Noumea, Wellington, Auckland, Pago Pago

1 Select [World Time] in 1 menu.

The [World Time] screen appears.

2 Select the time you wish to display in [Time Setting].

Select (Hometown) or (Destination).

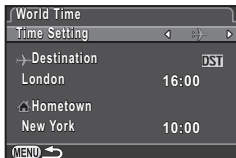

3 Select [Destination] and press .

The [Destination] screen appears.

4 Use to select a city.

Use to change the region.

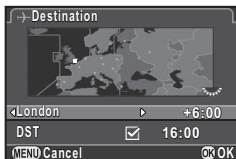

5 Select [DST] (daylight saving time), and use to select or .

6 Press .

The [World Time] screen reappears.

7 Press twice.

Memo

- Select [Hometown] in Step 3 to change the city and DST settings for the hometown.
- and the local date and time appear in the control panel when [Time Setting] is set to .

Text Size



You can set the size of the text that appears on the menu screens to [Standard] (normal display) or [Large] (magnified display).

When set to [Large], the character string on which the menu cursor is placed is magnified approximately 1.5 times vertically.

Sound Effects



You can set the volume of the sound effects and whether the sound effects are emitted during the following operations.

- In-focus
- AE Lock
- During [Self-timer] countdown in drive mode
- During [Remote Control] countdown in drive mode
- When the camera is ready to shoot with the mirror raised
- When the function of the arrow keys () is switched by pressing
- When operating One Push File Format with

Memo

- You can turn all the sound effects off by setting for [Volume].



LCD Display



Sets the general display settings for the LCD display.

The following settings are available.

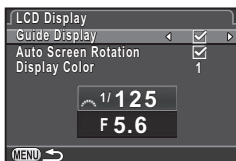

Guide Display	Displays the operation guides when the exposure mode is changed.
Auto Screen Rotation	Displays the status screen and control panel vertically if the camera is held vertically.
Display Color	Sets the display color of the status screen, control panel and menu cursor.

LCD Display Settings



Adjusts the brightness, saturation and the color of the monitor (B-A, G-M).



Available operations

▲▼	Selects an item.
◀▶	Adjusts the value (15 levels for each item).
○	Resets the adjustment value.
☀	Displays a captured image in the background so you can adjust the color while viewing the image.

USB Connection



Set the USB connection mode (MSC or PTP) when connecting this camera to a computer via a commercially available USB cable.

Memo

- Refer to the “Operating Manual” to connect the camera to a computer. (📖 p.87)

HDMI Out



Set the output format of the HDMI terminal.

Auto	The maximum resolution supported by the AV device and camera is automatically selected.
1080i	1920×1080i
720p	1280×720p
576p	1280×576p
480p	720×480p

Memo

- When the HDMI output format is set to [1080i] or [720p], the display may appear with a screen design that differs from that of the camera.



Folder Name



When images are captured with this camera, a folder is automatically created and the captured images are stored in it. Each folder name consists of a sequential number from 100 to 999 and a string of 5 characters.

The character string for the folder name can be changed.

1 Select [Folder Name] in menu and press **▶**.

The [Folder Name] screen appears.

2 Select a folder name and press **OK**.

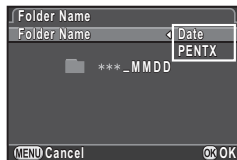

Date	The two digits of the month and day on which the picture was taken are assigned after the folder number. [MMDD] appears according to the date format set in [Date Adjustment]. Example) 101_0125: for images taken on January 25th
PENTX	The character string "PENTX" is assigned after the folder number. Example) 101PENTX

Proceed to Step 5 if you do not need to change the folder name.

3 Press **▼**, and then press **▶**.

The text-entry screen appears.

4 Change the text.





Enter 5 single-byte alphanumeric characters.

Text selection cursor



Text input cursor

Available operations

- | | |
|---|--|
|  | Moves the text selection cursor. |
|  | Moves the text input cursor. |
|  | Enters a character selected with the text selection cursor at the position of the text input cursor. |
|  | Resets the adjustment value to the default setting. |

5 After entering the text, move the text selection cursor to [Finish] and press **OK**.

6 Press **MENU** twice.

Memo

- A folder with a new number is created when the folder name is changed.
- A maximum of 500 images (100 images for Eye-Fi card) can be stored in a single folder. When the number of captured images exceeds 500, a new folder is created with the number following the number of the folder currently being used. In Exposure Bracketing shooting, images will be stored in the same folder until shooting is completed.
- When [Select multiple images] or [Select a folder] of [RAW Development] is selected, a folder with a new number is created, and the JPEG images are stored in it.



⚠ Caution

- The maximum folder number is 999. After the folder number reaches 999, you cannot capture new images if you attempt to change the folder name or create a new folder, or when the file name number reaches 9999.

Create New Folder



A folder is created with a new number when the next image is saved. When a memory card is inserted in both SD1 and SD2 slots, a new folder is created on both memory cards.

File Name



One of the following string of characters is used as the file name prefix depending on the [20. Color Space] (p.R41) setting of the C3 menu.

Color Space	File Name
sRGB	IMG Pxxxx.JPG
AdobeRGB	_IMGxxxx.JPG

The first four characters can be changed to a character string of your choice.

1 Select [File Name] in menu and press **▶**.

The [File Name] screen appears.

2 Select or and press **▶**.

The text-entry screen appears.

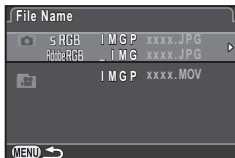

3 Change the text.

Up to 4 single-byte alphanumeric characters can be entered.

Text selection cursor



Text input cursor

Available operations

	Moves the text selection cursor.
	Moves the text input cursor.
	Enters a character selected with the text selection cursor at the position of the text input cursor.
	Resets the adjustment value to the default setting.

4 After entering the text, move the text selection cursor to [Finish] and press **OK**.

5 Press **MENU** twice.

Memo

- When [Color Space] is set to [AdobeRGB], the file name prefix is “_” and first three characters of the entered character string becomes the file name.
- For movies, regardless of the [Color Space] setting, the file name is “IMG Pxxxx.MOV” or a file name with the entered string of characters.

Caution

- “INDX” cannot be used as the character string for the file name.

File No.



Each file name consists of a string of 4 characters and a sequential number from 0001 to 9999. In [Sequential Numbering], you can set whether to continue the sequential numbering for the file name when a new folder is created.

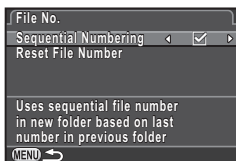

<input checked="" type="checkbox"/>	Continues the sequential numbering for the file name even if a new folder is created.
<input type="checkbox"/>	Returns the file number of the first image saved to a folder to 0001 each time a new folder is created.

Select [Reset File Number] to reset the file number to its default value.

Memo

- When the file number reaches 9999, a new folder is created and the file number is reset.

Copyright Information



Sets the photographer and copyright information embedded in Exif data.

- 1 Select [Copyright Information] in menu and press **▶**.

The [Copyright Information] screen appears.

- 2 Use **◀ ▶** to set [Embed Copyright Data].



<input type="checkbox"/>	Does not embed copyright information in the Exif.
<input checked="" type="checkbox"/>	Embeds copyright information in the Exif.

- 3 Select [Photographer] or [Copyright Holder], and press **▶**.

The text-entry screen appears.

- 4 Change the text.

Up to 32 single-byte alphanumeric characters and symbols can be entered.

Text selection cursor

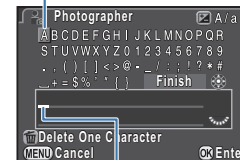

Text input cursor



Available operations

▲▼◀▶	Moves the text selection cursor.
☺	Moves the text input cursor.
Ⓜ	Switches between upper and lower case letters.
OK	Enters a character selected with the text selection cursor at the position of the text input cursor.
Ⓜ	Deletes a character at the position of the text input cursor.

5 After entering the text, move the text selection cursor to [Finish] and press **OK.**

6 Press **MENU twice.**

Memo

- The Exif information can be checked using the provided software "Digital Camera Utility 5". (📖 p.88)
- When [Embed Copyright Data] is set to on, a copyright symbol (©) appears on the status screen and LCD panel.

Flicker Reduction

You can set the power frequency (50Hz, 60Hz) to that used in the region. The camera controls the exposure and cuts down on the screen flicker based on the selected power frequency.

Auto Power Off

You can set the camera to turn off automatically if unused for a set period of time. Select from [1min.], [3min.], [5min.], [10min.], [30min.] or [Off].

Memo

- The Auto Power Off function does not work during slideshow playback, when connected to a computer with a USB cable, or when transferring images using an Eye-Fi card.

Wireless Memory Card

A memory card with a built-in wireless LAN "Eye-Fi card" (Wi-Fi transmission) or a "Flucard" compatible with this camera can be used. By using these cards, images can be transferred from the camera to a computer or other device via wireless LAN. Sets the camera action for when an Eye-Fi card or a Flucard is used.

1 Select [Wireless Memory Card] in  menu and press **▶.**

The [Wireless Memory Card] screen appears.

2 Select [Action Mode].

Items that can be set are displayed according to the type of card inserted.

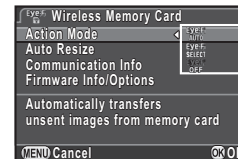

Eye-Fi card

AUTO	Transfers images automatically when there are any images that have not yet been transferred. For movies, only files under 2 GB can be transferred.
SELECT	Transfers images or a folder that are selected in [Eye-Fi Image Transfer] of the playback mode palette. Movies cannot be transferred.
OFF	Stops the communication function.

Flucard



ON	Enables wireless data transfer with Flucard.
OFF	Disables wireless data transfer with Flucard.

3 Specify [Auto Resize].

When set to , JPEG images are saved to the Eye-Fi card or Flucard at the size of $\times 9$.

4 Press **MENU** twice.





Caution

- Be sure to insert an Eye-Fi card or a Flucard in the SD2 slot. If it is inserted in the SD1 slot, the wireless LAN function cannot be used. When an Eye-Fi card or a Flucard is not inserted in the SD2 slot, the [Wireless Memory Card] settings of the  3 menu cannot be set.
- Set up a wireless LAN access point on a computer for the card connection.
- For RAW images, the success of transfer depends on the specifications and settings of the Eye-Fi card in use.
- Images may not be transferred when the battery level is low.
- It may take time to transfer a large number of images. The camera may turn off if the internal temperature of the camera becomes high.
- For precautions on the Eye-Fi card, refer to “About Eye-Fi Cards” ( p.5).

Memo

- A communication terminal, such as a smartphone or tablet, can be used to operate this camera when a Flucard compatible with this camera is inserted. Refer to the Flucard manual for details on how to use the card.
- When an Eye-Fi card is used, 100 images can be stored in a single folder. For RAW+ images, two files are counted as one image.
- In Step 2, select [Communication Info] to check the Wireless LAN information, and [Firmware Info/Options] to check the firmware version of the cards.
- When [Reset Transfer Settings] is selected in Step 2, the [Action Mode] setting is returned to their default values.



Reset 3

Resets the settings of the direct keys and for the items of the  menu,  menu,  menu,  menu, control panel, and playback mode palette.

Caution

- The Reset function is not available when the mode dial is set to **U1**, **U2** or **U3**.

Memo

- The following functions are not reset.
 - [Save USER Mode] in the  4 menu
 - [Language/言語], [Date Adjustment], city and DST settings for [World Time], [Text Size], [Copyright Information] and [Flicker Reduction] in the  menu
 - **C** menu

Pixel Mapping 4

This maps out and corrects defective pixels in the CMOS sensor.

Caution

- Pixel Mapping cannot be performed when the battery level is low. Use the optional AC adapter kit or load a fully charged battery.



Dust Alert is the function that detects dust adhering to the CMOS sensor and visually displays the location of the dust. You can save the detected image and display it when performing Sensor Cleaning of the **4** menu. (p.R37)
Make sure that the camera is in the following status.

- Attach a D FA645 or FA645 (**A** aperture position) lens.
- Set the focus mode on the lens to **AF**.
- Turn the Stills/Movie switching dial to **☐**.

1 Select [Dust Alert] in **4** menu and press **▶**.

The [Dust Alert] screen appears.

2 Fully display a white wall or other bright subject with no detail in the viewfinder and press the shutter release button fully.

After image processing is performed, the Dust Alert image appears.

If [The operation could not be completed correctly] appears, press **OK** and take another picture.

3 Check the sensor for dust.

Use **☐** to display the Dust Alert image at full screen display.

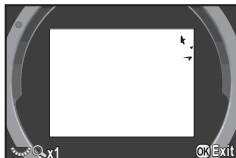

4 Press **OK**.

The Dust Alert image is saved and the **4** menu reappears.

Caution

- The exposure time may be long when using the Dust Alert function. Note that if the lens direction changes before processing is complete, dust will not be detected properly.
- Depending on the subject conditions or temperature, dust may not be detected properly.
- The Dust Alert function cannot be used when the shutter is locked.
- The Dust Alert image can only be displayed during sensor cleaning within 30 minutes after the image is saved. If more than 30 minutes elapse, save a new Dust Alert image and then perform sensor cleaning.
- The saved Dust Alert image cannot be displayed in playback mode.

Memo

- Regardless of the camera settings, the Dust Alert image will be taken with specific shooting settings.
- Only the latest Dust Alert image is saved to the SD1 slot memory card for approximately 30 minutes. If the sensor cleaning is performed during this time, the Dust Alert image can be checked while cleaning the sensor. If recording to the SD1 slot memory card is not possible, the image is not saved.

Dust Removal





This removes dust adhering to the CMOS sensor by applying ultrasonic vibrations to the filter on the front surface of the sensor for approximately one second. Set [Startup Action] and [Shutdown Action] to to turn the Dust Removal function on every time the camera is turned on/off.

Sensor Cleaning



Raise the mirror up and open the shutter to clean with a blower. If you use the Dust Alert function to detect dust on the sensor within 30 minutes before the sensor cleaning, the Dust Alert image appears on the monitor to enable you to check the location of dust.

- 1 Turn the camera off and remove the lens.**
- 2 Turn the camera on.**
- 3 Select [Sensor Cleaning] in  4 menu and press .**

The [Sensor Cleaning] screen appears.
- 4 Select [Mirror Up] and press .**

The mirror rises up.
The self-timer lamp blinks and [CIn] appears on the LCD panel.
If a Dust Alert image is saved, it appears.
- 5 Clean the CMOS sensor with a blower.**
- 6 Turn the camera off.**

The mirror automatically returns to its original position.

Caution

- Never use a spray blower or a blower with a brush. The CMOS sensor may be damaged. Do not wipe the CMOS sensor with a cloth.
- Do not put the tip of the blower inside the lens mount area. If the power is turned off, this may cause damage to the shutter, CMOS sensor and the mirror.
- When the battery level is low, the message [Not enough battery power remaining to clean sensor] is displayed on the monitor. Install a fully charged battery. If the battery capacity becomes low during cleaning, a warning beep will sound. In this case, stop cleaning immediately.

Memo

- Please contact your nearest service center for professional cleaning as the CMOS sensor is a precision part.
- You can use the optional Imagesensor Cleaning kit O-ICK1 when cleaning the CMOS sensor.



Select the memory card in either the SD1 or SD2 slot and format it. ( p.36)

Caution

- Do not remove the memory card while formatting. The card may be damaged.
- Formatting deletes all data, both protected and unprotected.

Memo

- When a memory card is formatted, the volume label "645Z" is assigned to the card. When the camera is connected to a computer, the memory card is recognized as a removable disk with the name "645Z".

Displays the camera's firmware version.



C Custom Setting Menu

1. EV Steps

C1

Sets the step interval for exposure.

Setting	Exposure Setting Value
1/3 EV Steps	±0.3, ±0.7, ±1.0, ±1.3, ±1.7, ±2.0, ±2.3, ±2.7, ±3.0, ±3.3, ±3.7, ±4.0, ±4.3, ±4.7, ±5.0
1/2 EV Steps	±0.5, ±1.0, ±1.5, ±2.0, ±2.5, ±3.0, ±3.5, ±4.0, ±4.5, ±5.0

2. Sensitivity Steps

C1

Sets whether to adjust the sensitivity in increments of 1 EV step or in accordance with the [EV Steps] setting for exposure.

3. Meter Operating Time

C1

Select from [10sec.], [20sec.], [30sec.] or [Continue] for the exposure metering time. If [Continue] is selected, metering continues until the shutter release button is pressed fully or the camera is turned off.



4. AE-L with AF Locked

C1

Exposure is locked when focus is locked.

5. Link AE and AF Point

C1

The metering point and the AF point can be linked when the metering mode is set to  (Multi-segment), or when the focusing area selection mode is set to  (Select) and the metering mode is set to  (Spot). Exposure is adjusted in accordance with the position of the selected AF point.

6. Auto EV Compensation

C1

Compensates automatically when the proper exposure cannot be determined.

7. Bulb (B) Mode Options

C1

Sets the function of the shutter release button in **B** mode.

Type1	Continuous exposure while the shutter release button is pressed.
Type2	Press the shutter release button to start exposure, and press it again to end exposure.

Memo

- The camera operates in the same manner when shooting with a remote control unit.

8. Bracketing Order

C2

Sets the order for Exposure Bracketing shooting.

Setting	Frames	Order
0 - +	2 frames	0 → -1, 0 → +1
	3 frames	0 → -1 → +1
	5 frames	0 → -1 → +1 → -2 → +2
- 0 +	2 frames	-1 → 0, 0 → +1
	3 frames	-1 → 0 → +1
	5 frames	-2 → -1 → 0 → +1 → +2
+ 0 -	2 frames	0 → -1, +1 → 0
	3 frames	+1 → 0 → -1
	5 frames	+2 → +1 → 0 → -1 → -2
0 + -	2 frames	-1 → 0, +1 → 0
	3 frames	0 → +1 → -1
	5 frames	0 → +1 → -1 → +2 → -2

9. One-Push Bracketing

C2

Shoots all frames with one press of the shutter release button when using Exposure Bracketing.

10. WB Adjustable Range

C2

Fine-tunes the white balance when the light source is specified.

Fixed	Color temperature of the light source is fixed.
Auto Adjustment	Automatically performs fine-tuning.

11. WB When Using Flash

C2

Select [Auto White Balance], [Multi Auto White Balance], [Flash] or [Unchanged] for the white balance when the flash discharges.

12. AWB in Tungsten Light

C2

Adjusts the tungsten light color tone when [White Balance] is set to [Auto White Balance].

Subtle Correction	Keeps the tungsten light color tone.
Strong Correction	Applies a stronger correction of the tungsten light.

13. Color Temperature Steps

C2

Sets the unit of the white balance color temperature to [Kelvin] or [Mired].

14. Superimpose AF Area

C2

The selected AF point lights red in the viewfinder.

15. AF.S Setting

C3

Selects the action priority for when the focus mode is set to **AF.S** and the shutter release button is fully pressed.

Focus-priority	The shutter is not released until the subject is in focus.
Release-priority	The shutter is released even if the subject is not in focus.

16. 1st Frame Action in AF.C

C3

Selects the 1st frame action priority for when the focus mode is set to **AF.C** and the shutter release button is fully pressed.

Release-priority	Starts shooting immediately, even if the subject is not in focus.
Auto	Determines whether focus adjustment is necessary depending on the focusing conditions.
Focus-priority	Starts shooting when the subject is in focus.

17. Action in AF.C Continuous

C3

Selects the action priority during Continuous Shooting for when the focus mode is set to **AF.C**.

Focus-priority	Prioritizes tracking the subject.
Auto	Determines which to prioritize, focus or framerate.
FPS-priority	Prioritizes the speed of Continuous Shooting.

18. Hold AF Status

C3

Sets whether to maintain the focus for a certain amount of time when the subject happens to move out of the selected focusing area after being focused. Selects [Off], [Low], [Medium], or [High].

19. AF with Remote Control

C3

Enables autofocus with remote control.

20. Color Space

C3

Sets the color space of image files to [sRGB] or [AdobeRGB].



Memo

- Image file names vary depending on the color space setting. (p.R32)

Color Space	File Name
sRGB	IMGPxxxx.JPG
AdobeRGB	_IMGxxx.JPG

21. LCD Panel Illumination

C3

Sets the LCD panel backlight setting to [Low] or [High].

22. Save Rotation Info

C4

Saves the rotation information of an image according to the orientation of the camera when the image was shot.

23. Save Menu Location

C4

The last menu tab displayed on the monitor is saved, and it is displayed again the next time **MENU** is pressed.

24. AF Fine Adjustment

C4

Adjusts the AF focus position.

1 Select [24. AF Fine Adjustment] in C4 menu and press **▶**.

The [24. AF Fine Adjustment] screen appears.

2 Select [Apply All] or [Apply One] and press **OK**.

Apply All	Applies the same adjustment value to all lenses.
Apply One	Saves an adjustment value for the lens being used. (Up to 20 values)

3 Select [Setting] and adjust the value.

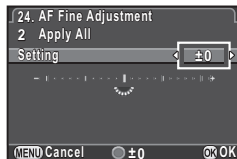

Available operations

▶ /	Adjusts the focus to a closer position.
◀ /	Adjusts the focus to a farther position.
○	Resets the adjustment value to the default setting.

4 Press **OK**.

The adjustment value is saved.

5 Press **MENU** twice.

The camera returns to standby mode.

Memo

- Check focus accuracy by magnifying the image during Live View ([p.39](#)) or Digital Preview ([p.67](#)).

25. Flash Sync Speed

C4

Selects the flash sync speed.

1/125	1/125 seconds
1/100 (1/90)	1/100 seconds at 1/3 EV Steps, 1/90 seconds at 1/2 EV Steps
1/80 (1/90)	1/80 seconds at 1/3 EV Steps, 1/90 seconds at 1/2 EV Steps
1/60	1/60 seconds

26. 4-way Controller Options

C4

Selects the operation of the arrow keys (▲▼◀▶) for when the focusing area selection mode is set to one of the following “Select” modes: and .

Type1	Switches the operation of ▲▼◀▶ to that for the Change AF Point mode or the direct key mode by pressing .
Type2	Switches the operation of ▲▼◀▶ to that for the direct key mode only when is pressed. While the focusing area selection mode is set to one of the “Select” type modes, the AF point can be changed using ▲▼◀▶.

Caution

- When [Type2] is set, regardless of the focusing area selection mode, the direct key operation for making settings such as those for Drive Mode are not available until is pressed.

27. Mirror Up Operation

C4





Set to [Off] to disable the Mirror Up dial operation.

28. Shake Reduction Options

C4

Select whether to activate Shake Reduction at the moment of capture only (Type1) or while pressing the shutter release button halfway (Type2).

Memo





- The Shake Reduction function is available when a lens with the SR system is used in  mode. In  mode, Shake Reduction can be activated from [Movie SR] of the  1 menu. ( p.R25)

29. Enable/Disable Controls

C5

Select the group of buttons and dials of which operation is temporarily disabled.

Type1	     
Type2	        

Turning  to the right while pressing  disables the operation of the selected group of buttons and dials. Turning  to the left while pressing  enables the operation of them.  is displayed on the status screen, LCD panel, Live View screen and in the viewfinder when the operation of the control interfaces is disabled.

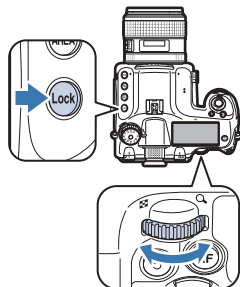

Reset Custom Functions

Resets all the settings of the Custom Setting menu to the defaults.

Memo

- The adjustment value of [24. AF Fine Adjustment] is not reset.

Appendix

Restrictions on the Combinations of Special Functions

×: Not available

	B Mode	HDR Capture	Exposure Bracketing	Mirror Lock-up Shooting	Lens Correction	Save RAW Data
Live View						
Drive Mode	Continuous Shooting	×	×			×
	Multi-exposure		×	×	×	
	Interval Shooting	×		×		×
	Interval Composite	×	×	×	×	×
Exposure Bracketing	×					
Flash		×				

Main Specifications

Model Description

Type	TTL autofocus, auto-exposure medium format digital SLR camera
Lens Mount	PENTAX 645Af2 mount with AF coupler, lens information contacts, and power contacts
Usable Lens	PENTAX 645Af2, 645AF and 645A mount lenses

Image Capture Unit

Image Sensor	Type: CMOS with a primary color filter Size: 43.8 × 32.8 (mm)
Effective Pixels	Approx. 51.4 megapixels
Total Pixels	Approx. 52.99 megapixels
Dust Removal	Image sensor cleaning using ultrasonic vibrations "DR II" with the Dust Alert function
Sensitivity (Standard output)	ISO AUTO/100 to 204800 (EV steps can be set to 1EV, 1/2 EV, or 1/3 EV)
Image Stabilizer	Lens-shift type (when a lens with SR system is used)

File Formats

Recording Formats	RAW (PEF/DNG), TIFF, JPEG (Exif 2.30), DCF 2.0 compliant
Recorded Pixels	JPEG: (51M: 8256×6192), (36M: 6912×5184), (21M: 5376×4032), (3M: 1920×1440) RAW: (51M: 8256×6192) TIFF: (51M: 8256×6192)
Quality Level	RAW (14bit): PEF, DNG JPEG: ★★★ (Best), ★★ (Better), ★ (Good), RAW + JPEG simultaneous recording available
Color Space	sRGB, AdobeRGB
Storage Media	SD, SDHC*, SDXC* memory card, Eye-Fi card, FLUCARD *UHS-I compatible
Dual Card Slot	Sequential Use, Save to Both, Separate RAW/JPEG, Copying images between slots possible

Storage Folder	Folder Name: Date (100_1018, 101_1019...) or a user-assigned name (default: PENTX)
Storage File	File Name: a user-assigned name (default: IMG*****) File No.: Sequential Numbering, Reset

Viewfinder

Type	Keplerian telescopic trapezoid prism finder
Coverage (FOV)	Approx. 98%
Magnification	Approx. 0.62× (55mm F2.8 at infinity), Approx. 0.85× (75mm F2.8 at infinity)
Eye-Relief Length	Approx. 21 mm (from the view window), Approx. 24.1 mm (from the center of lens)
Diopter Adjustment	Approx. -3.5 m to + 2.0 m ⁻¹
Focusing Screen	Interchangeable Natural-Bright-Matte focusing screen

Live View

Type	TTL method using CMOS image sensor
Focus Method	Contrast detection AF (Face Detection, Tracking, Multiple AF Points, Select, Spot) Focus Peaking: ON/OFF
Display	Field of view: approx. 100%, Magnified view (2×, 4×, 8×, 12×, 16×), Grid Display (Grid Style: 4×4 Grid, Golden Section, Scale, Square 1, Square 2, Grid Color: translucent black, translucent white), Histogram, Highlight Alert, Rotate Display 180°

LCD Monitor

Type	Tiltable TFT color LCD monitor featuring an air-gapless structure with an AR-coated, tempered-glass front panel
Size	3.2 inches
Dots	Approx. 1037K dots
Adjustment	Brightness, Saturation and Color adjustable

White Balance

Type	Method using a combination of the CMOS image sensor and the light source detection sensor
White Balance	Auto White Balance, Multi Auto White Balance, Daylight, Shade, Cloudy, Fluorescent Light (D : Daylight Color, N : Daylight White, W : Cool White, L : Warm White), Tungsten Light, Flash, CTE , Manual White Balance (up to 3 settings can be saved), Color Temperature (up to 3 settings can be saved), Copying the white balance settings of a captured image possible
Fine Adjustment	Adjustable ± 7 steps on A-B axis and G-M axis

Autofocus System

Type	TTL: phase-matching autofocus
Focus System	SAFOX 11, 27 AF points (25 cross-type focus points in the center)
Brightness Range	EV -3 to 18 (ISO100, at normal temperature)
AF Modes	Single AF (AF.S), Continuous AF (AF.C), Focus operation customizable
Focusing Area Selection Modes	Spot, Select, Expanded Area AF (S, M, L), Zone Select, Auto (27 AF Points)

Exposure Control

Type	TTL open aperture metering using 86K pixel RGB sensor Metering Modes: Multi-segment metering, Center-weighted metering, Spot metering
Metering Range	EV -1 to 21 (ISO100 at 55mm F2.8)
Exposure Modes	Program, Sensitivity Priority, Shutter Priority, Aperture Priority, Shutter & Aperture Priority, Manual, Bulb, Flash X-sync Speed, USER1, USER2, USER3
EV Compensation	± 5 EV (1/3 EV steps or 1/2 EV steps can be selected)
AE Lock	Button type (timer-control: two times the meter operating time set in Custom Setting), Continuous as long as the shutter release button is halfway pressed

Exposure Bracketing	2, 3 or 5 frames, Available with Continuous Shooting, Self-timer or Remote Control of the drive modes
---------------------	---

Shutter

Type	Electronically controlled vertical-run focal plane shutter
Shutter Speed	Auto: 1/4000 to 30 sec., Manual: 1/4000 to 30 sec. (1/3 EV steps or 1/2 EV steps), Bulb

Drive Modes

Mode Selection	Stills: Single Frame, Continuous (H, L), Self-timer (12 sec., 2 sec.), Remote Control (immediately, 3 sec., continuous), Multi-exposure (available with Continuous, Self-timer or Remote Control), Interval Shooting, Interval Composite Movie: Remote Control, Interval Movie Record
Mirror Lock-up Shooting	Available with Continuous, Self-timer, Remote Control or Multi-exposure
Continuous Shooting	Max. approx. 3 fps, JPEG (☐): ★★★ at Continuous H): up to approx. 30 frames, RAW: up to approx. 10 frames, TIFF: up to approx. 12 frames Max. approx. 1 fps, JPEG (☐): ★★★ at Continuous L): up to approx. 300 frames, RAW: up to approx. 25 frames, TIFF: up to approx. 15 frames *When the sensitivity is set to ISO100.
Multi-Exposure	Composite Mode: Additive, Average, Bright Number of Shots: 2 to 2000 images
Interval Shooting	Stills: Interval: 2 sec. to 24 hr., Number of shots: 2 to 2000 images, Start Interval: Now, Set Time Movie: Recorded Pixels: $\frac{4K}{FullHD}$ / $\frac{HD}{}$, Interval: 2 sec. to 1 hr., Recording time: 14 sec. to 99 hr., Start Interval: Now, Set Time



Flash

Flash Modes	Flash On, Flash On+Red-eye Reduction, Slow-speed Sync, Slow-speed Sync+Red-eye, P-TTL, Trailing Curtain Sync, contrast-control-sync, high-speed sync, wireless sync (available with a dedicated external flash)
Sync Speed	1/125 sec.
Flash Exposure Compensation	-2.0 to +1.0 EV

Capture Settings

Custom Image	Bright, Natural, Portrait, Landscape, Vibrant, Radiant, Muted, Bleach Bypass, Reversal Film, Monochrome, Cross Processing
Cross Processing	Random, Preset 1-3, Favorite 1-3
Noise Reduction	Slow Shutter Speed NR, High-ISO NR
Dynamic Range Settings	Highlight Correction, Shadow Correction
Lens Correction	Distortion Correction, Lateral Chromatic Aberration Correction, Peripheral Illumination Correction, Diffraction Correction
HDR Capture	Auto, Type1, Type2, Type3, Exposure Bracket Value adjustable, Auto Align (automatic composition correction function) available
Electronic Level	Displayed in viewfinder and LCD panel (horizontal direction only); displayed on LCD monitor (horizontal direction and vertical direction)

Movie

Recording Formats	MPEG-4 AVC/H.264 (MOV) *Motion JPEG (AVI) for Interval Movie Record
Recorded Pixels	 (1920×1080, 60i/50i/30p/25p/24p),  (1280×720, 60p/50p/30p/25p/24p)
Sound	Built-in stereo microphones, external microphone (stereo recording compatible), Recording Sound Level adjustable

Recording Time	Up to 25 minutes; automatically stops recording if the internal temperature of the camera becomes high.
Custom Image	Bright, Natural, Portrait, Landscape, Vibrant, Radiant, Muted, Bleach Bypass, Reversal Film, Monochrome, Cross Processing
Cross Processing	Random, Preset 1-3, Favorite 1-3
HDR Capture *Available only for Interval Movie Record	Auto, Type1, Type2, Type3, Exposure Bracket Value adjustable

Playback Functions

Playback View	Single image display, Multi-image display (6, 12, 20, 35, 80 thumbnails), Image magnification (up to 16×, 1× display and quick zoom available), Grid Display (Grid Style: 4×4 Grid, Golden Section, Scale, Square 1, Square 2, Grid Color: translucent black, translucent white), Rotated image display, Histogram (Y histogram, RGB histogram), Highlight Alert, Auto Image Rotation, Detailed Information Display, Copyright Information (Photographer, Copyright Holder), Folder Display, Calendar Filmstrip Display, Slideshow, GPS information (latitude, longitude, altitude, Coordinated Universal Time (UTC))
Delete	Single image, all images, select & delete, folder, Instant Review image
Digital Filter	Base Parameter Adj, Extract Color, Toy Camera, Retro, High Contrast, Shading, Invert Color, Unicolor Bold, Bold Monochrome, Tone Expansion, Sketch, Water Color, Pastel, Posterization, Miniature, Soft, Starburst, Fish-eye, Slim
RAW Development	Development options: Select single image, Select multiple images, Select a folder Development parameters: File Format (JPEG/TIFF), Aspect Ratio, JPEG Recorded Pixels, JPEG Quality, Color Space, Distortion Correction, Lateral Chromatic Aberration Correction, Peripheral Illumination Correction, Diffraction Correction, Color Fringe Correction, White Balance, Custom Image, Digital Filter, HDR, Sensitivity, High-ISO NR, Shadow Correction

Editing Features	Color Moiré Correction, Resize, Cropping (aspect ratio can be changed and tilt adjustment is available), Movie Edit (dividing a movie file and deleting unwanted segments), Capturing a JPEG still picture from a movie, Saving RAW Data, Image Copy, Eye-Fi Image Transfer
------------------	---

Customization

USER Modes	Up to 3 settings can be saved
Custom Functions	29 items
Mode Memory	11 items
Button Customization/ E-Dial Programming	<p> Button: One Push File Format, Optical Preview, Digital Preview</p> <p> Button: Enable AF1, Enable AF2, Cancel AF</p> <p>Preview Dial: Optical Preview, Digital Preview</p> <p> Button: LCD Panel Illumination, Modeling Flash, Test Flash</p> <p>E-dials (front/rear): customizable to each exposure mode</p>
Enable/Disable Controls	<p>Type1: </p> <p>Type2: ▲ ▼ ◀ ▶</p> <p> </p>
Text Size	Standard, Large
World Time	World Time settings for 75 cities (28 time zones)
Language	English, French, German, Spanish, Portuguese, Italian, Dutch, Danish, Swedish, Finnish, Polish, Czech, Hungarian, Turkish, Greek, Russian, Korean, Traditional Chinese, Simplified Chinese, Japanese
AF Fine Adjustment	±10 step, adjustment for all lenses or individual lenses (up to 20 can be saved)
Copyright Information	Names of "Photographer" and "Copyright Holder" are embedded to the image file. Revision history can be checked using the provided software.

Power Supply

Battery Type	Rechargeable Lithium-ion Battery D-LI90
AC Adapter	AC Adapter Kit K-AC132 (Optional)

Battery Life	Number of recordable images: approx. 650 images Playback time: approx. 400 minutes *Tested in compliance with CIPA standard using a fully-charged lithium-ion battery under the temperature of 23°C. Actual results may vary depending on the shooting conditions.
--------------	---

Interfaces

Connection Port	USB 3.0 (micro B), external power supply terminal, cable switch terminal, X-sync socket, HDMI output terminal (Type D), stereo microphone input terminal
USB Connection	MSC/PTP

Dimensions and Weight

Dimensions	Approx. 156 mm (W) × 117 mm (H) × 123 mm (D) (excluding protrusions)
Weight	Approx. 1550 g (including dedicated battery and an SD memory card) Approx. 1470 g (body only)

Accessories

Package Contents	Strap O-ST150, Large eyecup 645 O-EC107, Rechargeable Lithium-ion Battery D-LI90, Battery Charger D-BC90, AC plug cord, Software (CD-ROM) S-SW150 <Installed on the camera> Standard eyecup 645, Hot shoe cover Fk, Sync socket 2p cap, Body mount cap 645, triangular ring and protective cover
Software	Digital Camera Utility 5

Approximate Image Storage Capacity and Playback Time





(When using the fully charged battery)

Battery	Temperature	Normal Shooting	Playback Time
D-LI90	23°C	650	400 minutes

* The image storage capacity is based on measuring conditions in accordance with CIPA standards, while other data is based on our measuring conditions. Some deviation from the above figures may occur in actual use depending on the selected capture mode and shooting conditions.

Approximate Image Storage Capacity by Size

(When using a 16 GB memory card)

Recorded Pixels	JPEG Quality			RAW	TIFF
	★★★	★★	★		
 51M	424	967	1915	143	98
 36M	604	1372	2715	–	–
 21M	996	2256	4412	–	–
 3M	7376	15443	27455	–	–

* The number of storable images may vary depending on the subject, shooting conditions, selected exposure mode and memory card, etc.

Symbols

 menu	R5, R15
 menu	R8, R24
 menu	R8, R26
 menu	R9, R28
C menu	R11, R39
 mode	51

Numerics

180° Rotation Info	R15
1st Frame Action in AF.C	R41
4-way Controller Options	R42

A

AC adapter	32, 94
Accessories	10, 28, 94
Action in AF.C Continuous	R41
AdobeRGB	R41
AE Lock	50
AE-L with AF Locked	R39
AF area	45, 46
AF Button	R20
AF Fine Adjustment	R42
AF frame	39
AF Mode	44
AF point	45
AF with Remote Control	R41
AF.C	44
AF.S	44

AF.S Setting	R40
Aperture Priority Automatic Exposure mode	48
Aspect Ratio	78, 82
Auto (AF Active Area)	45
Auto EV Compensation	R39
Auto Image Rotation	R26
AUTO ISO Parameters	R17
Auto Power Off	R34
Auto Resize	R35
Auto Screen Rotation	R30
Auto White Balance (White Balance)	53
AV device	84
Av mode	48
AWB (White Balance)	53
AWB in Tungsten Light	R40
B	
B mode	48
Base Parameter Adj (Digital Filter)	79
Battery	30
Battery level	31
Bleach Bypass (Custom Image)	68
Bold Monochrome (Digital Filter)	79
Bracketing	62
Bracketing Order	R40
Bright (Custom Image)	68
Brightness histogram	21
Bulb (B) Mode Options	R39

Bulb Exposure mode	48
Button	12
Button Customization	R20

C

C (AF Mode)	44
Cable switch	95
Cable switch terminal	11
Calendar Filmstrip Display	75
Card access lamp	11
Center-weighted metering	47
Changing the image size	77
Charging the battery	30
Charging time	30
City	R28
Cloudy (White Balance)	53
Color Fringe Correction	82
Color Moiré Correction	78
Color Space	R41
Color Temperature (White Balance)	55
Color Temperature Steps	R40
Computer	87
Connecting to a computer	86
Continuous mode	44
Continuous Shooting	56
Contrast (Custom Image)	68
Contrast AF	R18
Contrast detection AF	44
Control panel	17, 41
Copyright Holder	R33

Copyright Information	R33
Create New Folder.....	R32
Cropping	78
Cross Processing (Custom Image)	69
CTE (White Balance)	53
Custom Image	68
Custom setting menu.....	R11, R39

D

Date Adjustment	35, R28
Daylight (White Balance)	53
Default settings	R5
Delete	73, R27
Delete all images	R27
Delete an image.....	73
Deleting a folder.....	75
Destination.....	R29
Detailed Information Display.....	20
Developing RAW images.....	82
Dial.....	12
Dial indicator	38
Diffraction Correction	R16
Digital Camera Utility 5	90, 91
Digital Filter.....	79
Digital Preview	67, R19
Diopter adjustment.....	37
Direct keys	41, R13
Display Color	R30
Display language	34, R28
Distortion Correction	R16

DNG	R15
D-Range Settings.....	R16
Drive Mode.....	56
DST (daylight saving time).....	R29
Dust Alert	R36
Dust Removal.....	R37
Dynamic range	R16

E

E-Dial Programming	R20
Electronic Compass	18, R18
Electronic Level.....	18, 23, R19
Enable/Disable Controls.....	R43
Error messages.....	97
EV bar scale.....	22
EV Compensation	50
EV Steps	49, R39
Exif	R33
Expanded Area AF (AF Active Area)	45
Exposure Bracketing	62
Exposure metering timer	47, R39
Exposure Mode	48
Exposure Mode (USER mode)	R15, R23
Exposure Setting (Movie).....	R24
Exposure warning	22
Extract Color (Digital Filter).....	79
Eyecup	37
Eye-Fi card.....	33, R34
Eye-Fi Image Transfer	R34

F

Face Detection (Contrast AF).....	46
File Format	R15
File Name	R32
File No.	R33
Filter Effect (Custom Image).....	68
Firmware Info/Options	R38
Fish-eye (Digital Filter)	79
Flash.....	64, 94
Flash (White Balance)	53
Flash compatibility	66
Flash compensation	65
Flash Mode.....	65
Flash On	65
Flash Sync Speed	48, R42
Flicker Reduction.....	R34
Flucard.....	33, 96, R34
Fluorescent - Cool White (White Balance).....	53
Fluorescent - Daylight Color (White Balance).....	53
Fluorescent - Daylight White (White Balance).....	53
Fluorescent - Warm White (White Balance).....	53
Focus Method.....	44
Focus Peaking.....	R18
Folder display	75
Folder Name.....	R31
Format	36, R38
Framerate	R24

Function settings..... 40

G

GPS R18

GPS Time Sync R18

GPS unit 96

Green button R20

Grid Display R19, R26

Guide Display 38, R30

H

HDMI Out R30

HDMI terminal 84

HDR Capture R16, R24

Help 91

High Contrast (Digital Filter) 79

High/Low Key Adj (Custom Image)... 68

High-ISO NR R17

Highlight Alert R19, R26

Highlight Correction R16

Histogram Display 21, R19

Hold AF Status R41

Hometown 34, R29

Hue (Custom Image) 68

I

Illumination Button R21

Image Capture Settings R15

Image Copy 77

Image finishing tone 68

Image plane indicator 11

Image Rotation 76

Image storage capacity R49

Initial settings 34

Initializing a memory card 36, R38

Installing software 88

Instant Review 38, R19

Interchangeable focusing screen 95

Interval Composite 60

Interval Movie Record 61

Interval Shooting 59

Invert Color (Digital Filter) 79

ISO AUTO Setting R17

ISO sensitivity 47

J

JPEG R15

K

Kelvin 55, R40

L

Landscape (Custom Image) 68

Language/言語 34, R28

Language setting 34, R28

Lat-Chromatic-Ab Adj R16

LCD Display R30

LCD Display Settings R30

LCD Panel 23

LCD Panel Illumination R41

Lens 26

Lens compatibility 28

Lens Correction R16

Link AE and AF Point R39

Live View 16, 39, R18

Locking exposure value 50

LS lens 29

M

M mode 48

M.U.P. 63

Macintosh 86

Manual Exposure mode 48

Manual White Balance 54

Memory R22

Memory card 33

Memory Card Options R15, R24

Menu 42, R5

Menu operation 42, R14

Meter Operating Time R39

Metering mode 47

Microphone 52

Miniature (Digital Filter) 79

Mired 55, R40

Mirror Up 63

Mirror Up Operation R42

Mode dial 38, 49

Mode dial lock button 38

Monitor 15

Monochrome (Custom Image) 68

Motion JPEG 61

Movie Capture Settings R24

Movie Edit 81

Movie menu R8, R24

Movie mode 51

Movie SR	R25
MSC	R30
Multi Auto White Balance (White Balance)	53
Multi-exposure	58
Multi-image display	74
Multiple AF Points (Contrast AF)	46
Multi-segment metering	47
Muted (Custom Image)	68

N

Names of parts	11
Natural (Custom Image)	68
Noise Reduction	R17

O

One Push File Format	R21
One-Push Bracketing	R40
Optical Preview	67

P

P mode	48
Pastel (Digital Filter)	79
PEF	R15
Peripheral Illumination Correction..	R16
Photographer	R33
Pixel Mapping	R35
Pixels	R15
Playback	39
Playback Info Display selection screen	19
Playback menu	R8, R26

Playback mode	39
Playback mode palette	72, R13
Portrait (Custom Image)	68
Posterization (Digital Filter)	79
Power	34
Power frequency	R34
Preview	67, R19
Preview Dial	67, R21
Program Automatic Exposure mode	48
Program Line	48, R18
Protect	83, R26
Protect All Images	R26
Provided software	88
PTP	R30

Q

Quality Level	R15
Quick Zoom	R26
QuickTime	86

R

Radiant (Custom Image)	68
RAW	R15
RAW/Fx Button	R20
Rec. Mode menu	R5, R15
Recordable time	51
Recorded Pixels	R15, R24
Recording Sound Level	R24
Red-eye Reduction	65
Remote Control	57, 96

Reset	R35, R43
Resize	77
Retro (Digital Filter)	79
Reversal Film (Custom Image)	68
RGB histogram	21
Rotate Display 180°	R19
Rotation	76
Rotation Direction (E-Dial Programming)	R20

S

Saturation (Custom Image)	68
Save as Manual WB	54
Save Menu Location	42, R41
Save RAW Data	38, 39, 40, R19
Save Rotation Info	R41
Save Settings (White Balance)	54
Save USER Mode	R22
SD Memory Card	33
Select (AF Active Area)	45
Select (Contrast AF)	46
Select & Delete	74
Self-timer	57
Sensitivity	47, 82
Sensitivity Priority Automatic Exposure mode	48
Sensitivity Steps	R39
Sensor Cleaning	R37
Sequential Numbering	R33
Set-up menu	R9, R28
Shade (White Balance)	53

Shading (Digital Filter)	79	Stills/Movie switching dial.....	38, 51	User registration	91
Shadow Correction	R16	Strap.....	26	User setting mode	48, R22
Shake Reduction	63, R25, R43	Superimpose AF Area.....	22, R40	V	
Shake Reduction Options.....	R43	Sv mode.....	48	Vertical position	18
Sharpness (Custom Image).....	68	Switch.....	12	Vibrant (Custom Image)	68
Shooting.....	38	Switching between the memory cards		Viewfinder.....	22
Shooting Info Display.....	18	39	Volume	R24, R29
Shooting information.....	15	Sync cord	64	Volume label.....	37
Shutter & Aperture Priority Automatic		Sync socket.....	64	W	
Exposure mode.....	48	Sync socket 2P cap.....	64	WARRANTY POLICY.....	105, R55
Shutter Priority Automatic Exposure		System requirements	86	Water Color (Digital Filter).....	79
mode.....	48	T		WB Adjustable Range	R40
Single image display.....	19, 39, 73	TAv mode	48	WB When Using Flash	R40
Single mode.....	44	Testing your camera	38	White Balance	53
Sketch (Digital Filter)	79	Text Size	35, R29	Wi-Fi transmission.....	R34
Slideshow	76, R26	TIFF.....	82, R15	Windows	86
Slim (Digital Filter)	79	Time Setting	R29	Wireless LAN.....	R34
Slow Shutter Speed NR.....	R17	Tone Expansion (Digital Filter).....	79	Wireless Memory Card.....	R34
Slow-speed Sync.....	65	Toning (Custom Image)	68	World Time	R28
Soft (Digital Filter).....	79	Toy Camera (Digital Filter).....	79	X	
Sound	51	Tracking (Contrast AF).....	46	X mode.....	48
Sound Effects	R29	TTL phase-matching autofocus.....	44	Z	
Speaker	11	Tungsten (White Balance).....	53	Zone Select (AF Active Area).....	45
Specifications.....	R45	Tv mode.....	48	Zoom display	73
Spot (AF Active Area).....	45, 46	U			
Spot metering	47	Unicolor Bold (Digital Filter)	79		
sRGB	R41	USB Connection.....	87, R30		
Standby mode.....	15	USB terminal	87		
Starburst (Digital Filter).....	79	U1/U2/U3 mode.....	48, R22		
Status Screen	16				
Stereo microphone	11				

WARRANTY POLICY

All our cameras purchased through authorized bona fide photographic distribution channels are guaranteed against defects of material or workmanship for a period of twelve months from the date of your purchase. Service will be rendered, and defective parts will be replaced without cost to you within that period, provided the camera does not show evidence of impact, sand or liquid damage, mishandling, tampering, battery or chemical corrosion, operation contrary to operating instructions, or modification by an unauthorized repair shop. The manufacturer or its authorized representatives shall not be liable for any repair or alterations except those made with its written consent and shall not be liable for damages from delay or loss of use or from other indirect or consequential damages of any kind, whether caused by defective material or workmanship or otherwise; and it is expressly agreed that the liability of the manufacturer or its representatives under all guarantees or warranties, whether expressed or implied, is strictly limited to the replacement of parts as hereinbefore provided. No refunds will be made on repairs by non-authorized service facilities.

Procedure During 12-month Warranty Period

Any camera which proves defective during the 12-month warranty period should be returned to the dealer from whom you purchased the camera or to the manufacturer. If there are no representatives of the manufacturer in your country, send the camera to the manufacturer, with postage prepaid. In this case, it will take a considerable length of time before the camera can be returned to you owing to the complicated customs procedures required. If the camera is covered by warranty, repairs will be made and parts replaced free of charge, and the camera will be returned to you upon completion of servicing. If the camera is not covered by warranty, regular charges of the manufacturer or of its representatives will apply. Shipping charges are to be borne by the owner. If your camera was purchased outside of the country where you wish to have it serviced during the warranty period, regular handling and servicing fees may be charged by the manufacturer's representatives in that country. Notwithstanding this, your camera returned to the manufacturer will be serviced free of charge according to this procedure and warranty policy. In any case, however, shipping charges and

customs clearance fees to be borne by the sender. To prove the date of your purchase when required, please keep the receipt or bills covering the purchase of your camera for at least a year. Before sending your camera for servicing, please make sure that you are sending it to the manufacturer's authorized representatives or their approved repair shops, unless you are sending it directly to the manufacturer. Always obtain a quotation for the service charge, and only after you accept the quoted service charge, instruct the service station to proceed with the servicing.

- **This warranty policy does not affect the customer's statutory rights.**
- **The local warranty policies available from our distributors in some countries can supersede this warranty policy. Therefore, we recommend that you review the warranty card supplied with your product at the time of purchase, or contact our distributor in your country for more information and to receive a copy of the warranty policy.**

For customers in USA
STATEMENT OF FCC COMPLIANCE

This device complies with Part 15 of the FCC Rules. Operation is subject to the following two conditions: (1) This device may not cause harmful interference, and (2) this device must accept any interference received, including interference that may cause undesired operation. Changes or modifications not approved by the party responsible for compliance could void the user's authority to operate the equipment. This equipment has been tested and found to comply with the limits for a Class B digital device, pursuant to part 15 of the FCC Rules.

These limits are designed to provide reasonable protection against harmful interference in a residential installation. This equipment generates, uses and can radiate radio frequency energy and, if not installed and used in accordance with the instructions, may cause harmful interference to radio communications. However, there is no guarantee that interference will not occur in a particular installation. If this equipment does cause harmful interference to radio or television reception, which can be determined by turning the equipment off and on, the user is encouraged to try to correct the interference by one or more of the following measures:

- Reorient or relocate the receiving antenna.
- Increase the separation between the equipment and receiver.
- Connect the equipment into an outlet on a circuit different from that to which the receiver is connected.
- * Consult the dealer or an experienced radio/TV technician for help.

For customers in Canada

This Class B digital apparatus complies with Canadian ICES-003.

Pour les utilisateurs au Canada

Cet appareil numérique de la classe B est conforme à la norme NMB-003 du Canada.

FOR CALIFORNIA, U.S.A. ONLY

Perchlorate Material-special handling may apply.
The lithium battery used in this camera contains perchlorate material, which may require special handling.
See www.dtsc.ca.gov/hazardouswaste/perchlorate

Declaration of Conformity
According to 47CFR, Parts 2 and 15 for
Class B Personal Computers and Peripherals

We: RICOH IMAGING AMERICAS CORPORATION

Located at: 633 17th Street, Suite 2600
Denver, Colorado 80202 U.S.A.
Phone: 800-877-0155
FAX: 303-790-1131

Declare under sole responsibility that the product identified herein complies with 47CFR Parts 2 and 15 of the FCC rules as a Class B digital device. Each product marketed is identical to the representative unit tested and found to be compliant with the standards. Records maintained continue to reflect the equipment being produced can be expected to be within the variation accepted, due to quantity production and testing on the statistical basis as required by 47CFR §2.909. Operation is subject to the following two conditions: (1) This device may not cause harmful interference, and (2) This device must accept any interference received, including interference that may cause undesired operation. The above named party is responsible for ensuring that the equipment complies with the standards of 47CFR §15.101 to §15.109.

Product Name: Lens-interchangeable medium-format digital SLR (Single Lens Reflex) Camera

Model Number: PENTAX 645Z

Contact person: Customer Service Manager

Date and Place: March, 2014, Colorado

Information for Users on Collection and Disposal of Old Equipment and Used Batteries



1. In the European Union

These symbols on the products, packaging and/or accompanying documents mean that used electrical and electronic equipment and batteries should not be mixed with general household waste.

Used electrical/electronic equipment and batteries must be treated separately and in accordance with legislation that requires proper treatment, recovery and recycling of these products.



By disposing of these products correctly you will help ensure that the waste undergoes the necessary treatment, recovery and recycling and thus prevent potential negative effects on the environment and human health which could otherwise arise due to inappropriate waste handling.

If a chemical symbol is added beneath the symbol shown above, in accordance with the Battery Directive, this indicates that a heavy metal (Hg = Mercury, Cd = Cadmium, Pb = Lead) is present in the battery at a concentration above an applicable threshold specified in the Battery Directive.

For more information about collection and recycling of used products, please contact your local authorities, your waste disposal service or the point of sale where you purchased the products.

2. In other countries outside the EU

These symbols are only valid in the European Union. If you wish to discard used products, please contact your local authorities or dealer and ask for the correct method of disposal.

For Switzerland: Used electrical/electronic equipment can be returned free of charge to the dealer, even when you don't purchase a new product. Further collection facilities are listed on the home page of www.swico.ch or www.sens.ch.



The CE Mark is a Directive conformity mark of the European Union.

RICOH IMAGING COMPANY, LTD.	2-35-7, Maeno-cho, Itabashi-ku, Tokyo 174-8639, JAPAN (http://www.ricoh-imaging.co.jp)
RICOH IMAGING EUROPE S.A.S	112 Quai de Bezons, B.P. 204, 95106 Argenteuil Cedex, FRANCE (http://www.ricoh-imaging.fr)
RICOH IMAGING DEUTSCHLAND GmbH	Am Kaiserkai 1, 20457 Hamburg, GERMANY (http://www.ricoh-imaging.de)
RICOH IMAGING UK LTD.	PENTAX House, Heron Drive, Langley, Slough, Berks SL3 8PN, U.K. (http://www.ricoh-imaging.co.uk)
RICOH IMAGING AMERICAS CORPORATION	633 17th Street, Suite 2600, Denver, Colorado 80202, U.S.A. (http://www.us.ricoh-imaging.com)
RICOH IMAGING CANADA INC.	1770 Argentia Road Mississauga, Ontario L5N 3S7, CANADA (http://www.ricoh-imaging.ca)
RICOH IMAGING CHINA CO., LTD.	23D, Jun Yao International Plaza, 789 Zhaojiabang Road, Xu Hui District, Shanghai, 200032, CHINA (http://www.ricoh-imaging.com.cn)

<http://www.ricoh-imaging.co.jp/english>

- Specifications and external dimensions are subject to change without notice.